

NEWS ADVERTISER



Pains, trains and automobiles

FEATURE/7

A beary good reason to celebrate

NAME DROPPING/16



PRESSRUN 44,600

24 PAGES

SUNDAY, FEBRUARY 24, 2002

OPTIONAL DELIVERY \$6/ \$1 NEWSSTAND

Durham looks for assist

Chairman calls for teamwork

BY MARTIN DERBYSHIRE
Staff Writer

PICKERING — Roger Anderson rolled into Pickering Monday night, telling councillors when the Region accomplishes things, it's thanks to teamwork.

"Municipalities can't tackle many issues on their own," the Durham chairman told Pickering council in his annual address. "We must work together."

Mr. Anderson read a laundry list of current and future regional road improvement projects on the go in Pickering and assured council he would continue to work for infrastructure investment in the city.

In addition, he said working together is paramount with the City

See **FUTURE** page 4



A.J. GROEN/ News Advertiser photo

Cap bearer Ian Sharp leads a procession out of St. Isaac Jogues Catholic Church Friday following the funeral for his sister Laura

Ellis. Ms. Ellis, a Toronto Police officer, was killed on the job Monday while riding in a police cruiser responding to a call.

Thousands say goodbye

Family, officers, others pay last respects to Durham woman, Toronto officer killed on the job

BY MARTIN DERBYSHIRE
Staff Writer

PICKERING — Sadness and grief filled the air Friday morning as more than 5,000 police officers from across Ontario, Canada and the U.S. came to Pickering to lay to rest one of their own.

Toronto Police Constable Laura Jean Ellis died in the line of duty Feb. 18 when the cruiser she was riding in crashed into a utility pole in Scarborough while responding to a possible break-and-enter call.

Const. Ellis is survived by her husband Tim and their one-year-old daughter Paige. She had returned to

work from maternity leave one month earlier and was reportedly on her last shift with the Toronto force anticipating a move to the Durham Regional Police Service, which would have been closer to the family's Courtice home.

Funeral services began at St. Isaac Jogues Catholic Church shortly after 10 a.m.

In his homily for Const. Ellis, Reverend Brad Massman painted the picture of a "bright young woman with a twinkle in her eye", a loving mother and wife, dedicated to religion and her job.

"Laura's death also reminds us

of how much we owe the men and women of her profession and firefighters and emergency medical personnel. Those who risk their lives each and every day to serve and protect us," he said. "Her life was truly a gift that touched the hearts of many."

Toronto Police Chief Julian Fantino also spoke at the service, telling the thousands of friends, family, and colleagues the "family" of police from around the continent feels the pain of her loss.

"She made the ultimate sacrifice coming to the aid of a stranger who asked for help," he said. "Laura was

a fine police officer and a credit to the police service. This is truly a tragic loss; we will miss her greatly."

Fighting back tears, Chief Fantino said notifying Const. Ellis's family of her death was his "most difficult moment since becoming a police officer."

"My heart ached for them then and my heart goes out to them now."

Pickering City Councillor Bill McLean, a Toronto police officer for 31 years before his recent retirement, attended the service and said

See **WHEN** page 4

WHY MOVE? IMPROVE WITH Carroll 686-2445

Lifestyle SUNROOMS

NOW OPEN!
Mon-Thurs 8am-6pm, Fri 8am-4pm,
Sat 10am-3pm, Sun 12pm-3pm

Westney Rd. HWY. 401 See us from the 401 in Ajax! 239 Station St. Harwood Ave.

Blaisdale MONTESSORI School

Best Private School
As voted by Ajax/Pickering Readers' Choice Awards

Call Head Office 905-509-5005
16 mths - grade 8
6 Campuses in Durham www.blaisdale.com

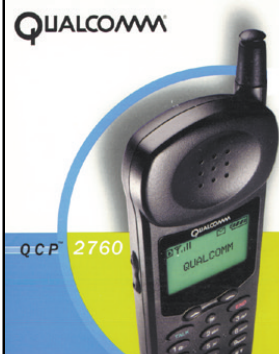

A picture perfect offer!

BONUS Pentax 35mm camera valued at \$100

Bring this ad in, and while quantities last, we'll include a BONUS Pentax 35mm camera when you purchase and activate any Qualcomm cellular phone!

Pickering Town Centre (905)837-1212
Whitby Mall (905)725-1212
843 King St. W., Oshawa (905)576-1212
Peterborough Portage Place (705)749-1212





SHERIDAN HAS BEEN.... CAUGHT WITH OUR PRICES DOWN!

2002 CHEVROLET CAVALIER VL COUPE

2002 CHEVROLET CAVALIER VLX SEDAN



OR PURCHASE FINANCING UP TO 36 MONTHS **0%**

• 5-Year or 100,000 km Powertrain Warranty • 2.2 Litre 115-HP Engine • 5-Speed Getrag Manual Transmission • 4-Wheel Anti-Lock Brakes • PASSLock Theft-Deterrent System • Rear Spoiler • Electric Trunk Release • Dual Front Air Bags

**No Money Down
No Sec. Deposit
No 1st Payment
JUST DRIVE AWAY**

\$226
with 2.9% LEASE RATE UP TO 48 MONTHS
SmartLease per month/48 months

CASH PURCHASE PRICE \$12,498



OR PURCHASE FINANCING UP TO 36 MONTHS **0%**

• 5-Year or 100,000 km Powertrain Warranty • 2.2 Litre 115-HP Engine • 4-Speed Automatic Transmission with Enhanced Traction Control • 4-Wheel Anti-Lock Brakes • PASSLock Theft-Deterrent System • Air Conditioning • AM/FM Stereo with CD • Remote Keyless Entry with Content Theft System • Power Door Locks • Electric Trunk Release • Tilt Steering • Tachometer • Dual Front Air Bags

**No Money Down
No Sec. Deposit
No 1st Payment
JUST DRIVE AWAY**

\$275
with 1.9% LEASE RATE UP TO 48 MONTHS
SmartLease per month/48 months

CASH PURCHASE PRICE \$16,798

**No Money Down
No Sec. Deposit
No 1st Payment
JUST DRIVE AWAY**

OR PURCHASE FINANCING UP TO 36 MONTHS **0%**



2002 ALERO GX COUPE BY OLDSMOBILE

• 5-Year or 100,000 km Powertrain Warranty • 2.2 Litre DOHC ECOTEC Engine • 5-Speed Getrag Manual Transmission • Air Conditioning • Cruise Control with Steering Wheel Controls • AM/FM RDS Stereo CD with 6-Speaker System • Rear Spoiler • 15" Aluminum Wheels • 4-Wheel Anti-Lock Brakes • 70/30 Split-Folding Rear Seat • PASSLock II Theft-Deterrent System • Power Locks/Trunk Release • And More

\$310
SmartLease per month/48 months

CASH PURCHASE PRICE \$19,688

SHERIDAN'S PREVIOUSLY ENJOYED VEHICLES! 1998's AT NO HAGGLE PRICES

SUNFIRE
4 cyl., auto, air,
74,316kms Stk# P4838
\$9,999

MALIBU
3100 V6, auto, air,
65,119kms Stk# P4886
\$11,999

• GMAC SMARTLEASE RETURNS
Optimum USED VEHICLES
 MANUFACTURER'S WARRANTY
 OPTIMUM 150 PT INSPECTION OF EVERY VEHICLE
 24 HOUR ROADSIDE ASSISTANCE
 30 DAY VEHICLE EXCHANGE

CADILLAC CATERA
3.0 V6, auto, air,
57,000kms Stk# P4855
\$19,999

SAFARI VAN
4.3 V6, auto, air
58,540kms Stk# P4743
\$16,999

SATURN SL-1
SOHC, 4 cyl., auto, air,
70,005kms Stk# P4879
\$9,999

MALIBU
3100 V6, auto, air,
52,025kms Stk# P4944
\$11,999

MALIBU 'LS'
3100 V6, leather, air,
63,280kms Stk# P4931
\$12,999

SEVILLE 'STS'
Northstar system
81,306kms Stk# P4961
\$25,999

BLAZER 'LT'
4.3 V6, auto, air
79,439kms Stk# P4922
\$19,999

SATURN SL-2
DOHC, 4 cyl., auto, air,
50,680kms Stk# P4888
\$9,999

MALIBU 'LS'
3100 V6, leather, air,
72,351kms Stk# P4818
\$12,999

GRAND AM 'SE'
3100 V6, auto, air,
60,584kms Stk# P4719
\$13,999

TRANS SPORT
3400 V6, auto, air
72,759kms Stk# P4732
\$15,999

CHEV EXT CAB
V8, auto, air, cass.
87,668kms Stk# P4641
\$17,999

Sheridan

Chevrolet • Oldsmobile • Cadillac

1800 Kingston Rd., Pickering
Across from the Mandarin

(905) 683-9333

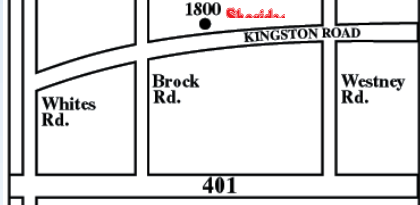

Prices are plus freight, air tax, admin., licence, fuel tax, P.S.T. & G.S.T. Finance offers subject to GMAC approval, cash rebates apply to dealer. Finance example: \$10,000 @ 0% = \$277.77 a mo. for 36 mo., C.O.B. \$0 for a total obligation of \$10,000.00. 2.9% lease rate available up to 48 months walkaway lease, 20,000 km annual allowance, 12¢/km. on excess. O.A.C. used vehicles are plus(lic.), Taxes + admin.

Rare police request made against sex offender

BY STEPHEN SHAW
Staff Writer

PICKERING - Police have invoked a seldom-used section of the Criminal Code in asking a court to impose harsh restrictions on the movements of a high-risk sex offender currently living in south Pickering.

According to an application filed with the Ontario Court of Justice in Oshawa, Durham Regional Police have grounds to fear Herman Tausendfrende will commit a sexual offence against a person under 14 years.

Under Section 810.1 of the Criminal Code, police are asking a judge to order the 47-year-old Park Cres-

cent man into a 12-month recognizance that would include a variety of stringent terms that, if broken, would lead to his arrest.

Currently, only one offender living in Durham is under such an order.

"We have some concerns he is going to reoffend and we are seeking the court's help to effectively manage him and protect the community," Sergeant Paul Malik, police spokesman, said when asked about the request.

Mr. Tausendfrende has prior convictions for break-and-enter, sexual offences against boys, trespassing at night and possessing child pornography.

Originally from Thunder Bay, he was sentenced in 1997 to 18 months in jail and three years' probation for child porn, trespassing and breach of probation.

He moved to Pickering upon his release and was on conditions as part of his probation, which expired in June 2001. Although he hasn't re-offended, police want him placed under terms similar to his expired probation.

Mr. Tausendfrende was arrested on the strength of the Sec. 810 application last month and was released on an undertaking pending his hearing, which has not yet been scheduled.

He has agreed to abide by the terms police are seeking until the hearing.

The conditions are staying away from any public pool, arena, library, school property, arcade, shopping centre, parks or

places persons under 14 are present or expected to be; not working or volunteering in a capacity placing him in a position of trust or authority over anyone under 14; not possessing knives, except for eating; not associating with anyone with a criminal record or involved in criminal activity; and reporting to police monthly.

The case was spoken to Wednesday in court and put over to March 13.

Funny fund-raiser

DURHAM - The Oshawa-Clarington Association for Community Living is selling tickets to a March 28 comedy show at Yuk Yuk's, 235 Bayly St. W., Ajax. Tickets are \$10 each. Call Justine Carlyle at 905-576-3011, ext. 302.

Please recycle



THE BEST STEAK AND SEAFOOD IN DURHAM!

Ranch Steakhouse & Seafood
89 Commercial Avenue, Ajax (905) 619-2138

DYNAMIC BOOK WAREHOUSE SALE

1 DAY ONLY
SATURDAY, MARCH 2ND
10 AM - 3 PM
SAVE UP TO 90% OFF SUGGESTED RETAIL

KINGSTON RD.
401
BAYLY ST.
ORANGEBROOKE CRT.

WE ACCEPT VISA, MASTERCARD, DEBIT CARDS

EVERYONE WELCOME! BOOKS 4 THE WHOLE FAMILY...
Thousand of titles to choose from
Great selections
Great prices
FREE TO FIRST 50 CUSTOMERS WITH THIS AD - 2002 CALENDAR

1734 ORANGEBROOKE CRT.
UNIT #10, REAR ENTRANCE
PICKERING, ONT.

PRECISE ~ ACCURATE ~ GUARANTEED

LIBERTY TAX SERVICE

- Income Tax Preparation
- Personal or Business
- FREE Electronic Filing
- Seniors Discount 15%
- Convenient Hours
- Open Year Round
- Money Back Guarantee
- Over 250 Locations

(905) 426-9936
TRANSIT SQUARE - AJAX GO STATION
MON.-FRI. 9 to 9, SAT. 9 to 5

BRING THIS AD LIMIT ONE COUPON PER RETURN.
SAVE \$10 NOT VALID WITH TAX RUSH OR ANY OTHER OFFER

Smoke-free bylaws - a question of public health

The Heart and Stroke Foundation of Ontario fully supports the move towards smoke-free bylaws for all Ontario municipalities, including a full ban on smoking within restaurants. Everything possible must be done to protect Ontarians against the health hazards posed by second-hand smoke and direct tobacco use.

Research by the Heart and Stroke Foundation has proven that smoking dramatically increases your risk of having a heart attack or stroke. Each year, 80,000 Canadians die from heart attacks and strokes and at least 20,000 of these deaths are due to smoking. That's 55 people every day! And it's not just the smoker who is at risk every time he or she lights up.

Second-hand smoke is just as dangerous as the smoke that is inhaled by the smoker. Second-hand smoke contains over 4,000 chemicals, and at least 50 of these are known to cause cancer.

As cigarettes burn at a lower temperature when they are not being inhaled, second-hand smoke contains more carbon monoxide, more tar and other dangerous chemicals than the smoke inhaled directly by the smoker. In fact, second-hand smoke kills more than 4,000 non-smokers in Canada every year. These people die from the same diseases that kill smokers, especially heart disease. The Heart and Stroke Foundation firmly believes that any exposure to second-hand smoke is harmful to your health and should be avoided completely.

Smoking is the largest preventative cause of heart disease and stroke. When a person quits smoking their risk of developing coronary heart disease begins to decline immediately and is reduced by half in the first year after quitting. In addition, 15 years after quitting smoking the risk of heart disease is approximately the same as that of a non-smoker. For stroke, the risk is reduced to that of a non-smoker within five to 15 years of quitting.

As a partner of Durham Lives!, a community coalition promoting physical activity, healthy eating and smoke-free living to reduce heart disease and cancer, the Heart and Stroke Foundation of Ontario strongly supports the call for a Region-wide smoke-free bylaw.

Sponsored by Durham Lives! and the Council for a Smoke-Free Durham Region

Welcoming New Patients Since 1985

AMBERLEA III DENTAL CENTRE

WALK-IN HOURS
Daily 8 a.m. - 9 p.m.
Sat. 10 a.m. - 4 p.m.

EMERGENCIES SEEN IN 2 HRS.
905-831-6666

EMERGENCY PAGER
AMBERLEA SHOPPING CENTRE
ON WHITES RD. PICKERING
BETWEEN FINCH & HWY 401

- FREE 2nd Opinion Consultation
- Chemiclave Sterilization
- Mercury Free White Fillings

Gentle and Caring Treatment

How long has it been?

10 MINUTE OIL CHANGE CENTRE
NO APPOINTMENT NEEDED.
WARRANTY APPROVED.

OIL CHANGE SPECIAL **FREE** FLASHLIGHT with batteries with every Oil Change Value \$4.99

from OIL & FILTER CHANGE
\$19.99*
10W30 PENNZOIL
*2 extra for 5W30 OIL
Includes 21 PT. Inspection
Oil change recommended every 3 months or 5,000 km.
COUPON EXPIRES APRIL 17, 2002

RADIATOR FLUSH & FILL SPECIAL **\$39.95** from OFFER EXPIRES APRIL 17, 2002

Castrol Valvoline
CANNOT COMBINE COUPON WITH ANY OTHER OFFER.
OPEN 7 DAYS A WEEK!
195 WESTNEY RD. (South of 401), AJAX
(905) 427-6796

Ask for your VIP oil change card

CANADIAN TIRE AUTO SERVICE

1735 PICKERING PKWY AT BROCK RD 905-686-2309 Mon - Sat 7:30 am - 6 pm Sun 9 am - 6 pm

CASTROL GTX

LUBE, OIL & FILTER

- 5 Litres of Castrol Motor Oil
- New Motomaster filter
- Lubricate the chassis

(NO SUBSTITUTES)
\$2.00 Enviro Charge Applies

19.95

Most Vehicles

DON'T PAY FOR 90 DAYS

- NO MONEY DOWN
- NO PAYMENT & INTEREST FOR 90 DAYS

When you use the Canadian Tire retail card, on approved credit when requested by customer at time of purchase.

Offer applies to all installed services in our Auto Centre. Excludes tires and batteries. Minimum invoice cost: \$150. *\$15 Administration Fee applies.

1/2 PRICE ALIGNMENT

with purchase of 2 tires

- Our licensed, trained technicians use the latest, computerized equipment to help extend the tread life of your tires.
- Installation of rear-wheel shims and adjustments extra, if required.

24.99

Most Cars Reg. \$49.99

When an officer dies 'it affects everybody'

WHEN from page 1

he has paid his last respects to more than 30 colleagues since the beginning of his career.

"We all feel the hurt and pain and we're here to show our respects," he said. As a former police officer "I can relate to what the family is going through."

Debbie Smith was born and raised in Pickering; she was a Toronto police officer for 13 years and now works with South Simcoe Police, just south of Barrie.

She is also a mother herself to a young daughter and came to Pickering

Friday with a large contingent of South Simcoe officers to pay their respects.

"When an officer dies it's a situation that affects everybody. It doesn't matter whether you know her or not, you can put yourself in that situation," she said. "We all do the same job. We put our lives on the line every day."

Const. Ellis's family has a long history with Durham police.

Eleanor Sharp, her mother, worked for more than 20 years for the Durham Regional Police Association as its executive assistant until becoming seriously ill more than a year ago and going on long-term disability.

Association president Terry Ryan,

who has known the family since Const. Ellis was a child, said he was "severely shaken" by the news of her death and visited with the family Monday after hearing about the tragedy.

"She was just a super, thoughtful person, a great cop and well respected," said Mr. Ryan.

Following Friday's ceremony, police on motorcycle and horseback led the funeral procession along Brock Avenue to Brock Road while the Toronto Police Service Pipe Band played and hundreds looked on. A wake was held in Const. Ellis's memory at the Metro East Trade Centre immediately following.

— With files from Stephen Shaw



A.J. GROEN/ News Advertiser photo

Pallbearers carry Laura Ellis's casket from the church following her funeral service.

Future looks bright

FUTURE from page 1

facing issues like the development of the provincially held Seaton lands and the building of a regional reliever airport on federally owned lands, both in north Pickering.

"There are some hurdles, but the future of Durham looks very bright," he added. "With things like Seaton, the Pickering airport, the expansion of (Hwy.) 407, and the new University of Ontario Institute of Technology, it's the beginning of a great new year and ITER (the experimental fusion reactor that may be awarded to Clarington later this year) will be the icing on the cake."

As far as challenges, Mr. Anderson said a continued focus on social housing is important since homelessness has become "a growing problem" here in Durham, and the Province's new 'Smart Growth' panel is something the Region "must monitor carefully in the future".

He added tax sharing from the federal and provincial governments would also be key for future growth in the region.

two special offers designed to build your interest.

for a limited time only, purchase these savings bonds.

CANADA PREMIUM BOND

2.00% 3.00% 4.25% 4.75% 6.00%

YEAR 1

YEAR 2

YEAR 3

YEAR 4

YEAR 5

SERIES 25 - ANNUAL COMPOUND RATE OF 3.99% IF HELD FOR 5 YEARS

CANADA SAVINGS BOND

1.30% 2.75% 4.00%

YEAR 1

YEAR 2

YEAR 3

SERIES 76 - ANNUAL COMPOUND RATE OF 2.67% IF HELD FOR 3 YEARS

Now's the time to buy New Canada Savings Bonds. With these attractive rates, both the Canada Savings Bond and the Canada Premium Bond make excellent **RRSP choices**. Both bonds are **100% guaranteed** by the Government of Canada. And both offer a **guaranteed return, flexibility and no fees**.

The Canada Savings Bond is cashable at any time, while the Canada Premium Bond can be cashed in annually. Buy them online, by phone or wherever you bank or invest. **And put your RRSP on solid ground.**

Visit www.csb.gc.ca to buy online or call 1 888 773 9999 to buy direct.

NEW CANADA SAVINGS BONDS
YOU'RE ON SOLID GROUND.

The Minister of Finance may end the sale of bonds at any time. To receive a tax receipt for 2001 income tax purposes, visit our Web site or call for deadline information.

SEARS*

SALE PRICES END SUN., MAR. 3, OR WHERE SEARS IS CLOSED, SAT., MAR. 2, 2002, WHILE QUANTITIES LAST

now 199⁹⁹

CRAFTSMAN 10" COMPOUND MITRE SAW
Save \$280. 15-amp saw with dust bag, stop block and extensions. Sears reg. 479.99.

ORDER: 098 428 587

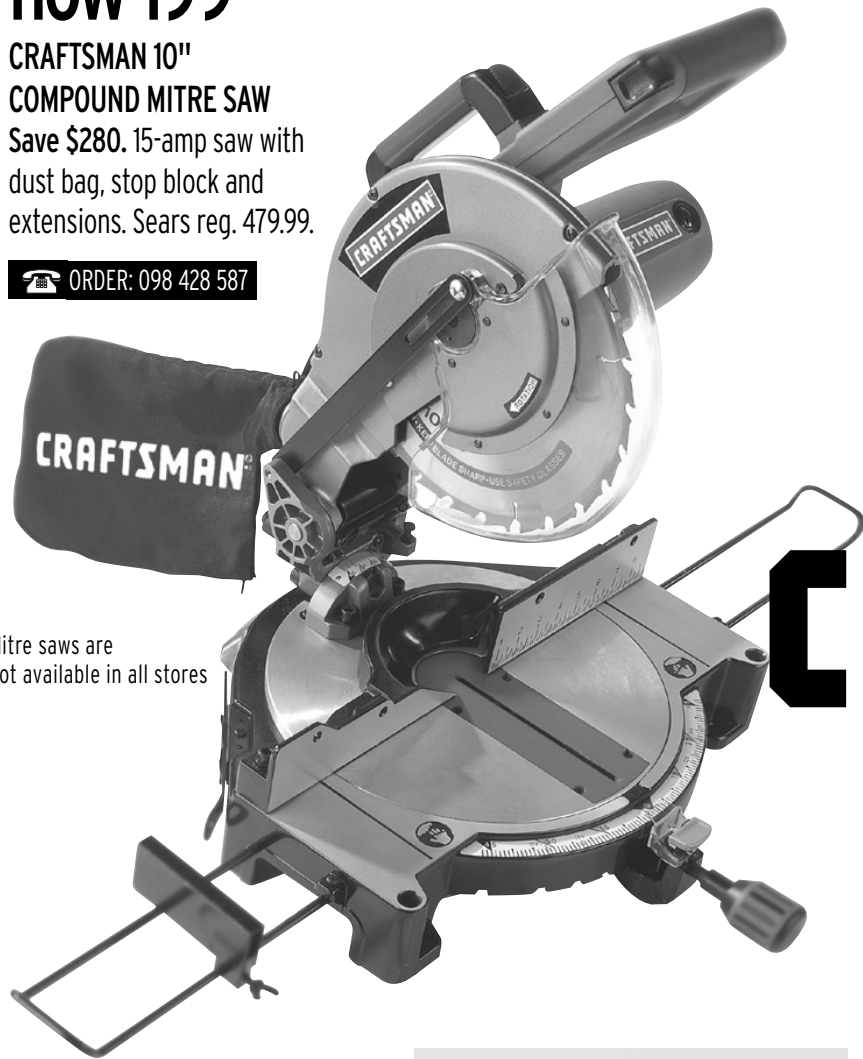

Mitre saws are not available in all stores



now 199⁹⁹

CRAFTSMAN® 10" COMPOUND MITRE SAW WITH EXTRA BLADE
Save \$280. 15-amp saw with dust bag, stop block and extensions. #28568. Sears reg. 479.99.



now 199⁹⁹

CRAFTSMAN 10" COMPOUND MITRE SAW
Save \$300. 15-amp saw. Dust bag, stop block, extensions and clamp. Sears reg. 499.99.

CRAFTSMAN[®] MD

now 159⁹⁹

CRAFTSMAN® CORDLESS DRILL WITH LIGHT
Save \$160. 3/8", 16.8V drill with 1-hour charger, 2 batteries and bag. #22284. Sears reg. 319.99.



now 99⁹⁹

CRAFTSMAN 'MILLENNIUM' 1/4" ROUTER
Save \$50. 8-amp router with built-in work light and carry case. #24599. Sears reg. 149.99.



now 59⁹⁹

CRAFTSMAN VARIABLE-SPD. ROTARY TOOL
Kit includes 70 accessories. #36081. Sears reg. 179.99.



Look for this symbol and shop by phone 1-888-607-3277

When you see this phone symbol on an item, it means you can buy it at your local Sears store, or order it over the phone by calling the above toll free number. If you shop by phone, you can pick up the item at any store or, for a nominal fee, you can have it delivered to your home.

Hardware is not available in our Yorkdale store. Home Environment Products available in most stores

save \$100

SHOP-VAC® WITH 36L STAINLESS STEEL TANK
Quiet pump vacuum, includes hose and accessories. #29336. Sears reg. 299.99. 199.99



save \$60

KENMORE® ELECTRONIC AIR CLEANER
Portable unit with 3-speed fan. White. #32937. Sears reg. 249.99. 189.99

Also available in Black. #32938



save \$150

KENMORE 26.5L CONSOLE HUMIDIFIER
Features automatic humidistat. Woodgrain. #29977. Sears reg. 279.99. 129.99
Also available in White. #29978



Editorial & OPINIONS

NEWS ADVERTISER FEBRUARY 24, 2002

Editorial

e-mail responses to shouston@durhamregion.com

Wow, what an Olympics!

Forget the medal count, Canada was centre stage at Salt Lake City

Journalists voted Canada the coolest country at the Winter Olympics. Of course, this was just before Wayne, 'Am I hot? Yah, I'm hot' Gretzky went on a rant about how our international hockey rivals "hate us."

We're usually the also-rans, not just in sports but also in most other aspects of world affairs. That's not the case at Salt Lake City, though.

How strange it was to see Jamie Salé and David Pelletier, who finally received the gold medal they so justly deserved in pairs figure skating, on the cover of U.S. newsmagazines 'Time' and 'Newsweek'.

The photogenic couple, who handled the entire judging controversy with style and grace, became the story of these Olympics. It was also gratifying to see Canada speak up and demand justice - and actually get it for once.

We're the fashion leaders with our much-admired warm-up outfits by Roots, so envied by other countries the U.S. and Great Britain teams chose to follow suit.

Our underdog women's hockey team defied the odds and atrocious refereeing to win the gold medal, beating the home country in front of a partisan crowd.

Catriona Le May Doan, who was the overwhelming favourite in her long-track speed-skating event, did not disappoint and came through with gold.

Our CBC wall-to-wall coverage featuring brilliant hosts Brian Williams, Ron MacLean and Terry Liebel and a crack team of experts, including Durham natives Barbara Underhill (figure skating) and Ron Richards (ski jumping) is admired around the world. In Olympics after Olympics, Americans clamour to watch CBC if they can, confident our analysts can beat their U.S. crew any day of the week.

Some of our athletes have not met the expectations they set for themselves but that is typical of every Olympics. We're sure our athletes gave their very best and isn't that what the Games are all about?

And today, on the final day of competition, it could not end any better. Our men's hockey team, after a sluggish and worrisome start, has caught fire and is ready to battle for gold. A sports event which will probably draw the biggest-ever TV rating in Canadian history, the battle for gold in men's hockey should be a game for the ages. Whether we win or lose, the battle to be the best is a noble pursuit that we can all admire.

Forget the medal haul. These have been Canada's Olympics.

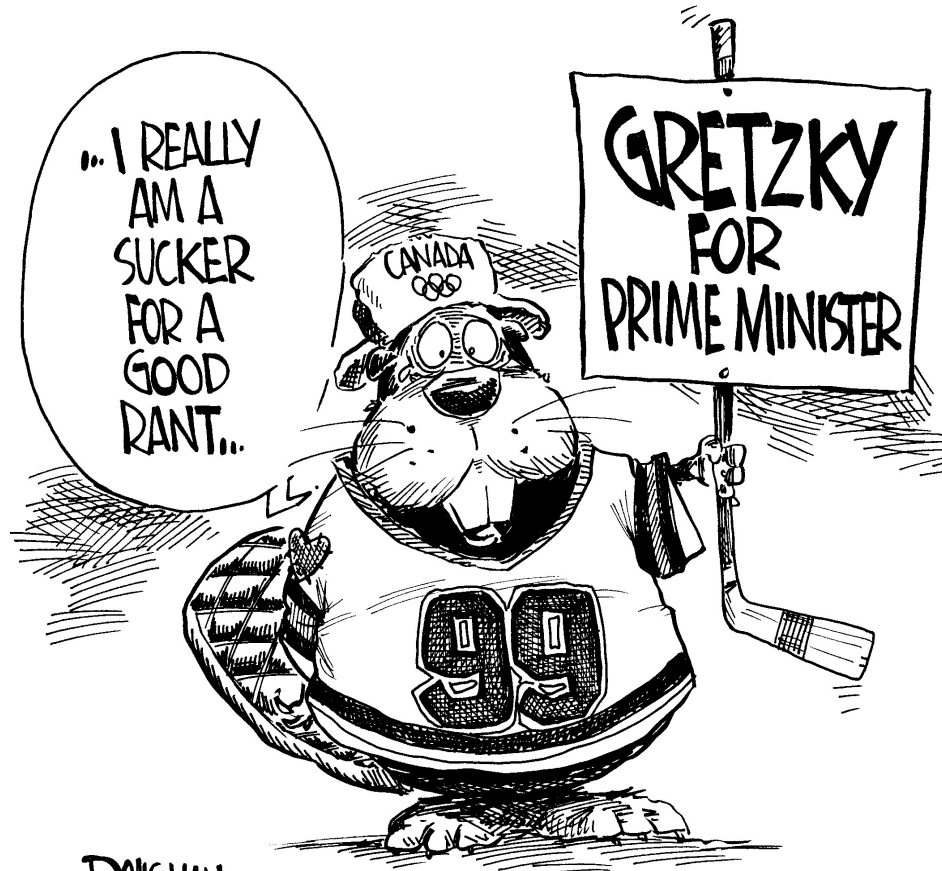

DOLIGHAN
WWW.DOLIGHAN.COM

Letters to the editor

e-mail responses to shouston@durhamregion.com

A refreshing approach to importance of faith

To the editor:

Re: 'Good God, belief-free society just doesn't add up,' opinion shaper column, Feb. 15.

It was with a great deal of pleasure that I read Kevin Belgrave's column. Rarely have I encountered so well balanced and reasonable an approach to an issue that, as a committed Christian, concerns me deeply.

How very refreshing to have someone state in a public forum that for Canada to ask its citizens to practise their citizenship in a manner that would deny the faith that is integral to their lives, forces them to

deny who they are and what they believe.

Would that more of us could accept a tolerance that does not deny the inherent need for faith in us, but which encourages the open dialogue among faiths of which Mr. Belgrave wrote. I wish to encourage you to print more opinion shaper columns that share his positive approach to living together in so culturally diverse a nation.

Peter Rhebergen,
Ajax

LETTERS POLICY

All letters should be typed or neatly hand-written, 150 words. Each letter must be signed with a first and last name or two initials and a last name. Please include a phone number for verification. The editor reserves the right to edit copy for style, length and content. Opinions expressed in letters are those of the writer and not necessarily those of the News Advertiser. We regret that due to the volume of letters, not all will be printed.

Business owners can make their own decisions

Ongoing talk of butt ban just not realistic in a world still filled with many smokers

Talk of Durham Region passing a bylaw to prohibit smoking in all public places has some residents breathing fire — and with good reason.

Just recently, five people, at random, were asked by this reporter what they thought of the Region's suggestion to go smoke-free: four out of five said 'No' — including an elderly man who said he was against smoking but still against a ban.

His argument is smokers have rights too. If there are places for non-smokers to go, why shouldn't there be places for smokers as well? He said people who don't smoke shouldn't have the right to enforce their beliefs on others.

Although I am ashamed to admit it, I am a dirty smoker. I totally under-



Crystal Crimi

Staff Writer

shouston@durhamregion.com

stand the concerns expressed by non-smokers regarding second-hand smoke: it makes you sick, you taste it in your food, and it is bad for your health.

But isn't the attempt to create a region-wide bylaw just another step toward banning cigarettes completely? Every year for decades now more and more restrictions on smoking in pub-

lic places have been brought into law. We've had a ban on advertising and sponsorship of events by tobacco companies. We've had an education blitz that has attempted — and largely failed — to stop teens from smoking. What we've seen is a hypocritical government that points its finger at the public and preaches about the horrors of smoking but gladly rakes in many millions in tax dollars.

If municipalities are so hard core about the ill effects of cancer sticks, why not ban them totally? Round smokers up and exile them to 'Quit Camp'. Create Smokers Anonymous and force the dragons to attend. That way, all the smokers will be reborn into a non-smoking world and restaurants and bars wouldn't take a loss in

business because smokers would cease to exist.

But that day isn't coming soon. Recent surveys show about 25 per cent of Canadians still smoke. The number has steadily dropped over the years but it is still very significant and an integral part of the restaurant and bar industry's clientele.

If it is a restaurant's choice to go non-smoking, fine. However, the Region does not own all bars and restaurants. Businessmen and women whose livelihoods may depend on the 'smoking trade' are the ones who will suffer under an enforced ban.

Until we have an entirely smoke-free world, let's allow business owners to decide how they want to operate.

NEWS
ADVERTISER
A Metroland Community
Newspaper

Tim Whittaker
Publisher

Joanne Burghardt
Editor-in-Chief

Steve Houston
Managing Editor

Duncan Fletcher

Director of Advertising
Retail/Distribution

John Willems

Director of Advertising
Real Estate/Automotive

Eddie Kolodziejczak
Classified Advertising
Manager

Abe Fakhourie

Distribution Manager

Lillian Hook

Office Manager

Barb Harrison

Composing Manager

News

905-683-5110

Sales

905-683-5110

Classifieds

905-683-0707

Distribution

905-683-5117

General Fax

905-683-7363

Death Notices

905-683-3005

Sincerely Yours

1-800-662-8423

E-mail

shouston@

durhamregion.com

Web address

durhamregion.com

130 Commercial Ave.,
Ajax, Ont. L1S 2H5

Publications Mail Sales
Agreement Number
1332791

The News Advertiser is one of the Metroland Printing, Publishing and Distributing group of newspapers. The News Advertiser is a member of the Ajax & Pickering Board of Trade, Ontario Community Newspaper Assoc., Canadian Community Newspaper Assoc., Canadian Circulations Audit Board and the Ontario Press Council. The publisher reserves the right to classify or refuse any advertisement. Credit for advertisement limited to space price error occupies. Editorial and Advertising content of the News Advertiser is copyrighted. Unauthorized reproduction is prohibited.

Pains, trains and automobiles



Travel industry finds it's a whole new world of business following Sept. 11

BY MARTIN DERBYSHIRE
Staff Writer

DURHAM — It's been more than five months since the terrorist attacks of Sept. 11 sent shock waves throughout North America and the world.

There was an immediate impact on how we all feel about safety and security in the skies after two commercial airliners crashed into the World Trade Center's twin towers in New York City, a third into the Pentagon in Washington, and a fourth was forced down in rural Pennsylvania.

Here in Canada, planes were grounded, and although only for a short time, it was long enough to have an effect on the delicate commercial airline industry.

We watched hundreds of Canadians abroad scramble to make alternative plans for returning home and eventually saw Canada 3000 crumble under the pressure of a changing climate in the travel industry.

As the days and weeks went by, stories were told of empty planes and airports that resembled ghost towns, leading to lost revenues. In addition, the far-reaching effects of an economic downturn hit the tourism industry, in Canada and abroad, the hardest.

Now, more than five months later, with one plastic-explosive-soled shoe aside, the airways have been mostly terror free.

For many Canadians, the questions about safety and security remain and not all are comfortable getting back on the planes. However, reports now indicate the Canadian tourism industry is showing signs of recovery.

The Canadian Tourism Commission's (CTC) Tourism Intelligence Bulletin, launched in late 2001 to feed information to the industry following the attacks, reports travel is recovering amid subsiding fears about further threats.

And, while the CTC suggests a weak economy, rather than fear, is the most significant deterrent to the industry's recovery, people are also choosing to take the train, the bus or their cars rather than fly.

"While on the whole, North Americans seem willing to travel again, the state of the economy has now become the greatest impediment to travellers," said Scott Meis, director of research of the CTC. "Less expensive getaways, closer to home, are becoming the preferred travel option, especially domestic and shorter-haul trips by train, bus or car. More people are returning to the skies, but passenger volumes are still dramatically off from last year."

Jeff Kerr, owner of the Kerr Bus Lines tour company just south of Port Perry, said the CTC is right: people are hopping back on the buses, seeing them as a terror-free travel option.

He said Kerr saw an immediate drop in

American travel destinations following Sept. 11, but that has since turned around. In addition, he finds there is a definite interest in the service from people who may not have chosen the bus in the past.

"We definitely had an immediate drop-off for all our U.S. stuff, some of the charters were cancelled," he said. "But, people are coming in and asking questions about bus tours, those that otherwise may have flown and say they're not flying again."

He said following the initial dip in travellers, they were sold out again by late fall.

"Nobody's too worried about terrorism now, it's just the value of the dollar they're concerned about... the biggest problem is the dollar and the cost of health insurance," he added. "The drop in business didn't kill us and we made up for it later in the year, but this is a tricky business. What's going to happen this year? We still have to see."

Last November, Via Rail unveiled its \$250,000 revitalization of its Oshawa station on Bloor Street. The work gave the building, constructed in 1968, a complete makeover.

Along with a new peaked roof and tower reminiscent of classic railway buildings of the past, the improvements to the station also include new seating, new ticket counters, air conditioning, improved washrooms, and new doors to improve access for disabled passengers.

An average of 14 Via trains stop in Oshawa on a daily basis and more than 1.3 million Via

and GO Transit passengers use the station annually.

Via also reports a renewed interest in riding the rails.

"Following the events of September 11, and the temporary shutdown of air traffic, Via responded to an immediate and dramatic increase in demand for passenger rail services," explained Marc LeFrançois, Via's president and chief executive officer. "Over the first week, Via carried up to 40-per cent more passengers in central and western Canada, and up to 70-per cent more in Atlantic Canada."

And, Mr. LeFrançois said the good news continues. "While traffic has declined from these extraordinary peaks, demand remains well above the company's pre-Sept. 11 projections, which were already aggressive in comparison to the industry as a whole," he said. "In the Quebec City-Windsor corridor (which includes Oshawa), demand remains strong, with ridership stabilizing at levels 15- to 20-per cent higher than last year."

Meanwhile, Mr. Kerr noted an interest in bus tours heading to Canadian destinations picked up when demand for U.S. vacations fell off, another fact supported by CTC statistics.

According to a Canadian travel intentions survey conducted last December, 38 per cent of Canadians intend to take a vacation within the next six months. Of those Canadians planning a winter or spring trip, 56 per cent indicated they will take a domestic vacation, up

from 51 per cent in October.

"Recovery for the tourism sector is moving faster in some areas than in others. In the short term, Canada's domestic travel market is where the greatest opportunities reside," said Jim Watson, president and chief executive officer of the CTC. "Whether it's driving to a ski resort, a weekend getaway or visiting friends, more Canadians are deciding to vacation here at home this year, helping at least partially to offset a slow recovery and continuing declines in other areas."

Also, a recent U.S. travel study reported U.S. residents are now turning their attention north. "Americans now view Canada as a safe international destination," said Mr. Meis. "We are starting to see the impact of redirected demand in terms of bookings for travel to Canada, particularly for short-haul leisure trips."

A third report, the CTC international travel forecast (winter 2001 update), predicts a slight rebound for the remainder of 2002.

"We expect to see a recovery in the United States and an expansion in existing leisure travel," stated Mr. Meis. "But the combination of economic conditions and continuing fear of air travel will have an impact on how Canadians travel and where, and it will make domestic tourism a more attractive option to many Canadians."

Most of those same sentiments are being echoed here in Durham.

Micky Jovkovic, owner of the Advantage Uxbridge Travel Centre, an Uxbridge agency catering to customers in Durham and other parts of the Greater Toronto Area, said although they felt an immediate crunch following Sept. 11, things are turning around quickly.

"We did lose a lot of money," he said. Immediately after Sept. 11 "we worked at saving a lot of people's vacations and rescuing them from destinations around the world... We had people stuck in the Caribbean and other parts of North America with no way to get back home."

And, those were just the immediate effects. Mr. Jovkovic said in the first month following the attacks there were a lot of people cancelling flights for fear of more terrorism.

"There were quite a few cancellations," he said. "People didn't want to fly, about 90 per cent of those that would have normally flown waited, after the first month that was cut to 30 to 45 per cent, then 10 per cent, and now those that should have gone are going."

In fact, Mr. Jovkovic said business is 10- to 15-per cent higher than normal because people who held off on vacations or visits to friends and family are flying the friendly skies once again this January and February.

"We're making up for the loss of business," he said. "Sept. 11, it's over... it's a fait accompli."

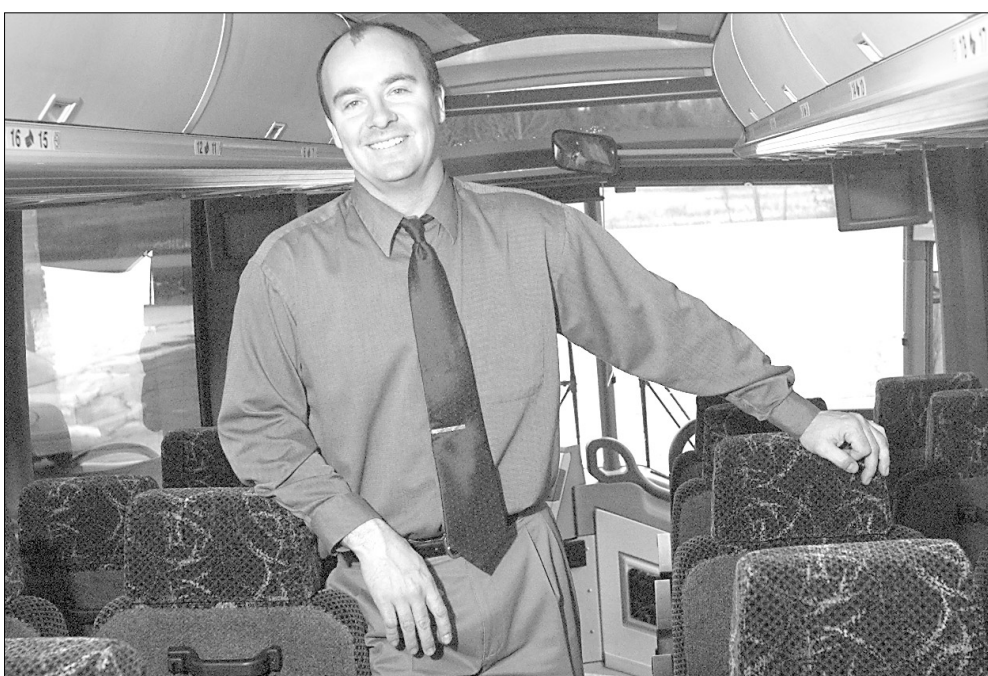

JASON LIEBREGTS/ News Advertiser photo

Jeff Kerr, owner of the Kerr Bus Lines tour company south of Port Perry, said the travel industry has undergone a number of changes following the Sept. 11 terrorist attacks. From his standpoint, more people are now hopping on the bus.

Choices laid out for Durham students

Pickering teen and former Olympian proof determination, goals the keys to success in life despite any or all obstacles

BY MIKE RUTA
Staff Writer

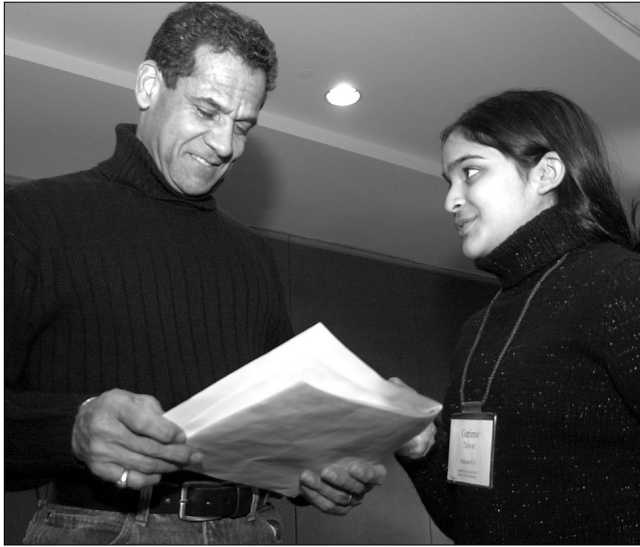

Garima Talwar, a student at Pickering's Parkside Public School, talks with Aubrey Bryce, one of the inspirational speakers recently on hand for a 'Choice is yours' conference at the Durham District School Board.

DURHAM — Choices set the course of our lives and may require a lot of thought.

However, family, friends and mentors are there to help you make good ones, local students heard Wednesday in Whitby.

Grade 7 and 8 students from schools in Bowmanville, Oshawa and Pickering attended a 'Choice is yours' conference at the Durham District School Board's Education Centre. Choice is yours is one of seven programs in the 'Together we light the way' model, a pilot project that involves the entire community helping youngsters build self-esteem, respect and responsibility.

Students heard first-hand about the importance of making good choices from two speakers.

Soon after his birth, Kariym Joachim, a Grade 9 student at Dunbarton High School in Pickering, was diagnosed with a genetic disorder called Treacher Collins syndrome. Kariym's physical challenges include severe hearing loss and a doctor told his parents he would never speak, but they rejected that assessment and were determined he would.

"An example of this happened when I was two years old," Kariym told students. "One day I pointed to the refrigerator for milk. My mom said to me, 'you're not getting any milk out of this fridge unless you say milk, milk'."

His mother was not satisfied with "mmm mmm", his attempt to say the word, until in anger Kariym shouted "milk".

He told students how he had to deal with fellow stu-

dents staring at and teasing him, and how he made the choice to remain positive and do well in school.

Step by step, Kariym relayed how his confidence increased when he made tough choices, like entering a speech contest in Grade 5 for the deaf and hard of hearing. He entered again the following year and was surprised to win a \$250 gift certificate.

"The choice to enter these contests has really helped me become a better public speaker and not to be afraid to take on a larger audience," Kariym said. "I sometimes

wonder, if I made a different choice, would I be here speaking to you today."

He plans to become an ear, nose and throat doctor.

"I was very surprised with his optimism," said Garima Talwar, a Grade 8 student at Pickering's Parkside Public School, moments after Kariym spoke. "He just takes a negative and changes it into a positive. He's just a year older than me and I'm surprised with his maturity."

Speaking about the difficulty of making some choices, and how apprehension can make them seem even

harder, Garima noted Kariym's advice to focus on all the available options.

Laura Harris, a Grade 8 student at Dr. Ross Tilley Public School in Bowmanville, could relate to Kariym's desire to become a doctor. She has a congenital heart disease and estimates she has been to the Hospital for Sick Children 100 times. It has spurred her interest in becoming a cardiologist.

"I'm going to have a lot of things to overcome if I want to do that," Laura said, noting Kariym's speech "kind of gives you a little more confidence".

The second speaker, Aubrey Bryce, told students he was a 16-year-old living in Guyana when one day he was taking a bus to visit a friend and saw a sticker.

"It said, Mexico '68 on it," said Mr. Bryce, explaining it referred to the 1968 Summer Olympics in Mexico City, then a year-and-a-half away.

A cycling enthusiast and junior who had never competed for his country, he boldly told his friend he was going to compete in the Olympics.

"He didn't believe me, but I made a choice, I was going to go there," Mr. Bryce said.

He made it to the

Olympics with a lot of hard work and said going "brought a lot of structure to my life."

"When you make choices, you always want to make a good choice. And a lot of times when we are children, we really don't have enough information on our own to make good choices."

He advised students to seek the support and counsel of people they trust.

More recently, Mr. Bryce made the tough decision to leave a high-paying position at General Electric to follow

his dream of being a coach of multi-sport athletes.

"Money is not the only currency of success," he told students, emphasizing family, friends and good health are important.

Garima almost stumped Mr. Bryce with a tough question.

"You seem to have a lot of control in your life," she said. "Have you ever not been in control and what did you do to change that?"

Mr. Bryce replied, "If you decide what you want to do, you have chosen to do it."

Angel Tours & Entertainment Inc.
RIDE THE ONLY WINGS THAT NEVER LEAVE THE GROUND

Oshawa Sunday Express - 5.5 hr stay Buffet Coupon compliments of Casino Rama Oshawa.....@ 8:00 a.m. Ajax.....@ 8:15 a.m. Pickering.....@ 8:30 a.m. Arrives Casino approx. 10:00 a.m. Departs Casino @ 3:30 p.m. Commencing February 3, 2002	Oshawa Monday Express - 4 hr stay \$10.00 Coin Voucher/\$5.00 Food Coupon Compliments of Casino Rama Oshawa.....@ 3:30 p.m. Ajax.....@ 3:45 p.m. Pickering.....@ 4:00 p.m. Arrives Casino approx. 5:30 p.m. Departs Casino @ 9:45 p.m. Commencing February 4, 2002
---	--

Call a Live Angel to Reserve Your Seat on the Next Oshawa Angel Express To:

CASINO RAMA
Toll Free 1 877 732 6435
Visit our web site to learn more: www.angeltour.com

Calling all Group Leaders!
When you book your next Group excursion to Casino Rama™, Don't forget to ask about our Group Leader Loyalty Program!
** Must be 19 years of age or older and have valid government issued photo identification to board buses destined for Casino Rama™. Program is subject to availability and may change without notice. Must have a valid Players Passport Card to obtain complimentary coupon.

CULLEN HEATING & AIR CONDITIONING
SERVING DURHAM REGION SINCE 1970

Air Conditioning Sale

KEEPRITE Authorized Dealer

NEW! KEEPRITE SUPER QUIET SOUND LEVEL 7.0 BELS HIGH EFFICIENCY 10.9 S.E.E.R.

NEW 2002 OPTIMA Model III

BOOK NOW & SAVE

FREE ESTIMATES 725-9731

Learn About Electrical Re-Regulation

ENERGY RESTRUCTURING 2002

Tuesday, February 26th, 2002 8:00 a.m. to 5:00 p.m.
at Holiday Inn, Oshawa 1011 Bloor Street East, Oshawa, Ontario

Energy Seminars FREE to the public!
8:30 am to 11:30 pm

Home Owner Business Owners
Everyone with questions about energy re-regulation: Don't miss this event!

LUNCHEON KEYNOTE ADDRESS
Floyd Laughren, Chair, Ontario Energy Board (registered attendees only)

Come out and learn about the fixed rate offers by retailers.
Energy experts will be on hand from 2 p.m. to 5 p.m.

Presented in Cooperation With:

- Ontario Ministry of Energy Science and Technology
- Ontario Power Generation
- Oshawa PUC Networks Inc
- Sempra Energy Trading (Canada) Limited
- Veridian / First Source Energy
- Toronto Hydro Energy Services Inc.
- Durham Business Times
- This Week newspapers
- News Advertiser

What's on The Agenda

- Restructuring goals
- How the market works
- Market pricing
- Role of the energy generator
- Saving energy dollars
- Informative Speakers
- Energy Management Displays
- Lunch (\$25 members, \$35 non-members)

Chamber of Commerce GREATER Oshawa
Established 1928

For Further Information Contact Greater Oshawa Chamber of Commerce 44 Richmond Street West, Oshawa, Ontario L1G 1C7 Phone 905-728-1683 Fax 905-432-1259 www.oshawachamber.com

Say good-bye to homework frustrations.

Our certified teachers uncover skill gaps and address specific needs, which helps children feel better about homework and themselves. Call Sylvan today to find out how you can see a dramatic increase in your child's confidence.

FIRST PICKERING PLACE
1550 Kingston Rd., Pickering
(905) 839-9637

SYLVAN LEARNING CENTRE
Learning feels good.
www.educate.com

We're online: durhamregion.com

This moment brought to you by Sylvan.

Sports Medicine Clinics

Pickering Sports Medicine & Wellness Centre welcomes Dr. Ronald Vandersluis who conducts a series of sports medicine clinics Friday mornings.

Dr. Vandersluis is a specialist in knee, shoulder and sport injuries and will be bringing his expertise to Pickering and Ajax clients. Bracing needs, orthopaedic assessment, physiotherapy assessment and advice regarding sports activity and injury management will be addressed at the clinic. It will focus on all levels of sports participants from children to mature athletes and recreational enthusiasts.

Dr. Vandersluis was awarded a scholarship to attend the University of Toronto Medical School and graduated with honours. He has completed an athroplasty and reconstructive knee and hip fellowship in Toronto. Dr. Vandersluis also received a scholarship for Orthopaedic Sports Medicine in Sydney, Australia and completed a second fellowship at the North Sydney Orthopaedic and Sports Medicine Centre. He is currently an active staff member at the Scarborough Hospital and specializes in reconstructive knee ligament and shoulder surgery.

Pickering Sports Medicine & Wellness Centre has been operating since April 2001 and is located in the Pickering Recreation Complex at 1867 Valley Farm Rd. on the upper level. Angela Dye is the director and works along side Lily Yang and Alka Sahadath as Registered Physiotherapists. Laurene Mckay and Kevin Canning are the Registered Massage Therapists. Angela has worked in Pickering, Ajax and Durham Region for 14 years and has been practising out-patient physiotherapy and rehabilita-

tion for 25 years. Occupational Therapists and social work services are also available.

"With the Sports Medicine Clinic we hope to reach out to all individuals and teams in Pickering and Ajax who need orthopaedic consultation in a speedy comprehensive and effective manner," says Angela. "So they can return to sports and activities as soon as possible."

The clinic is open every day and also provides evening treat-

ment and Saturday morning treatment. They offer services for those receiving WSIB and extended health care benefits and those injured in motor vehicle accidents.

The Centre also operates a community rehab company, Integrated Rehab Professionals to service clients in their homes for Physiotherapy, Occupational Therapy and Social Work services.

For more information about all of their services call (905) 839-8886.

IF

- TIME
- QUALITY
- GENTLE DENTAL CARE

ARE IMPORTANT TO YOU

WE ARE AVAILABLE TO SERVE YOU
WE WELCOME NEW PATIENTS
WE ♥ PEOPLE OF ALL AGES

24 HOUR EMERGENCY SERVICE
3 Harwood Ave. S., Ajax, Ontario
(South of Hwy. #2)



DR. JOSEPH A. MISKIN, DENTIST

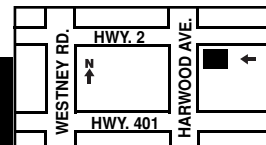

686-4343

WEIGHT LOSS THRU HYPNOSIS

"Achieve your dream weight"

NO TAPES • NO DIET • NO WILLPOWER

- Custom, personalized program
- Certified Hypnotist at all sessions
- Supportive, caring environment



Alpha Change **905-428-1091**
HYPNOSIS CENTRE

158 Harwood Ave. S., Suite 207, Ajax

Call Now For **FREE Consultation**

Registered Nutritionist

"Highway to Health"



- ♥ Lose weight
- ♥ Increase your energy level
- ♥ Detoxify your body
- ♥ Sleep better
- ♥ Improve your quality of life

Call **Evelyn Arbour**
360 Bayly St. Unit #2, Ajax
From Pick. call 905-683-8532
Other areas call 905-431-1928

Laser Hair Removal

Written Guarantee



LCI ~ Pickering First Pickering Place

1550 Kingston Rd. Suite 202, 1-866-SO-SMOOTH, (905) 831-1110

LCI ~ Markham 404 & Hwy 7

445 Apple Creek Blvd., Suite 122, 1-866-237-6667, (905) 415-2737

2 TYPES F LASER FOR LIGHT & DARK SKINS BOTH FDA APPROVAL FOR PERMANENT HAIR REDUCTION.

LASER

MOST COMPANIES ONLY HAVE ONE TYPE OF LASER, MANY OF THEM ARE NO LONGER MANUFACTURED.

LCI'S EXCLUSIVE COMFORT AIR COOLING PAIN FREE SYSTEM

PAINLESS

CHILL-TIP, SPRAY-GEL-THEY SIMPLY DO NOT WORK AS WELL.

LOWEST PRICE GUARANTEED. FREE TREATMENTS INSURE THE LOWEST PRICE.

PRICE

DO NOT BE MISLEAD BY 1/2 PRICE OR ONE TIME TREATMENT SPECIALS, THE TOTAL COMPARATIVE PRICE IS WHAT COUNTS.

30-MONTH PRE-PAID WRITTEN GUARANTEE - THE LOWEST IN THE INDUSTRY.

GUARANTEE

OUR COMPETITORS SIMPLY DO NOT PROVIDE A WRITTEN GUARANTEE AS WELL AS FREE TREATMENTS.

SOME COMPETITORS CLAIM THEIR LASER IS 5X FASTER. THIS IS SIMPLY NOT TRUE. LCI'S CYNOSURE LASERS WITH COOLERS ARE EXTREMELY EFFICIENT.

SPEED

5X FASTER - THE LASER COMPANY THAT MADE THIS CLAIM NO LONGER MAKES THIS STATEMENT OR EVEN MANUFACTURES THIS PRODUCT.

20 CLINICS IN CANADA LCI HAS PERFORMED OVER 100,000 TREATMENTS, THE MOST IN THE INDUSTRY.

CONVENIENCE

NO COMPANY HAS MORE THAN 4 CLINICS IN CANADA

new image... new ATTITUDE... new wardrobe... new me!



Full Service Weight Loss Programs.*

Lose up to 7 lbs. per week!

Canada's fastest growing weight control company.

Join Us Today!

Allison Did It!

162 inches SMALLER 120 pounds LIGHTER 100 percent HAPPIER



"I lost 120 pounds with not only the Herbal Magic Weight Loss Plan, but with the uplifting encouragement of the staff. I feel like a whole new person, healthy and proud!"

"Most importantly, I did it for me."



contact us @
905-426-9261
250 Bayly St. W.
Ajax

905-420-0003
1163 Kingston Rd.
Pickering

165 Centres Across Canada
From British Columbia to Nova Scotia

Herbal Magic
Systems International
Weight Management and Nutritional Centres

www.herbalmagic.ca

*offer expires Feb. 21, 2002

Allergies?

NO NEEDLES.

Printed Results, Accurate

Eczema, weight gain, diabetes, food cravings, constipation, Irritable bowel & diarrhea, ADHD, arthritis, depression, PMS, lack of energy?



Test for 220 Foods Environment & more! (for ages 4 & up)

1550 Kingston Rd. (BN Natural Foods)
Call today for an Appointment
(905) 837-6627

WE Want to See You Smile!

Your Denturist Can Help

FREE CONSULTATIONS

- Complete & Partial Dentures
- Evening & Saturday appointments
- Removable Dentures on Implants
- All Insurance Plans Accepted
- Same Day Relines
- Implant Supported Dentures
- Repairs while you wait
- No G.S.T. and No P.S.T.

Pickering Denture Clinic

Andre Maragh, DD (Denturist)
1792 Liverpool Rd., Pickering
905-420-2652



BETTER HEALTH

Hypnosis Helps Clients Overcome Bad Habits

You have tried dieting, only to feel guilty later when you cheated on your diet. You have tried jogging, but have little motivation to get out and do it on a regular basis. You have prepared an excellent report for work, but feel nervous to read it in public. It's time you turn to the Positive Changes Hypnosis Centre (PCH) for lasting results and to relax your mind.

More people quit smoking through hypnosis than from all other methods combined. It is the safest way to lose weight, increase confidence, relieve stress, increase motivation, enhance athletic ability and overcome phobias.

Rudy, director at Ajax PCH explains that hypnosis deals directly with the root of fears and anxieties in our minds. Most people know they have to change certain habits, but lack the willpower. In the case of weight loss, so many contradicting diets such as high protein, high carbohydrates, no fat and so on, are actually harmful to your health.

"All other methods are just treating the symptoms," says Rudy. "Hypnosis helps to create changes in the core of the mind where changes need to occur to be natural, spontaneous and permanent."

Our minds work on two levels, conscious and subconscious. We make decisions think and act with our conscious mind. Our subconscious controls our habits. When we are hypnotized the conscious mind is relaxed and the subconscious becomes more aware. Positive suggestions by the hypnotist are readily

accepted in this altered state.

This is a similar state to the period we go through just before falling asleep and upon awakening in the morning.

Hypnosis is 100 per cent safe. Your mind has values and morals and no one can suggest anything that goes against your ethics. In fact a free half-hour consultation before the process begins is necessary to determine if you can even be hypnotized. You can only be hypnotized if you want to.

At PCH, clients learn self hypnosis techniques they can use at any time in their life to overcome stress and other

problems.

"We want our clients to learn how to relax on their own so they are not dependent on anybody or anything, including us," says Rudy. "We teach our clients how to maintain what they have achieved."

Every aspect of PCH is positive and confidential. The centre itself is best described as a vacation place for the mind. Consultations are in private rooms, with comfortable furniture, plants and light and sound technology that have been scientifically proven to relax the brain. PCH hypnotists are recognized by the

American Board of Hypnotists, the National Guild of Hypnotists, the Society of Psycho-Linguistic Practitioners, Time Line Therapy Association.

"People walk out of here feeling their batteries have just been recharged," says Rudy. Hypnosis became a recognized practice in 1958 by the American Medical Association. The Positive Changes Hypnosis Centres have been in business

since 1961; the Ajax centre has been operating since September 2001.

All hypnosis sessions are tailored to the individual. If you have tried to make lifestyle changes in the past only to become frustrated at the side effects and short term results, visit the Positive Changes Hypnosis Centre for the ultimate self improvement solution. Call today for a free consultation at (905) 686-7717.

PICKERING VILLAGE DENTURE CLINIC
DENTURE SPECIALISTS

Functional Dentures...One Good Reason To Smile!

REPAIRS (1 hr.) * Relines * Complete, Partial Dentures

NEW PERMANENT, SOFT DENTURE LINER
Implant Supported Dentures



NO GST NO PST

William Steil, DD, F.C.A.C.(A)
Charles Wm. Steil, D.D.

84 Old Kingston Rd. W.
PICKERING VILLAGE, AJAX



Call today for free consultation
683-4294
After hours 428-8801

R R I V E R

CHIROPRACTIC

The Gates of Pickering Plaza
300 Kingston Rd. Unit #13
Pickering, ON L1V 6Z9
(905) 509-1333

Open 6 Days A Week for Your Convenience

Dr. Raymond Lee, D.C.
Chiropractor, Acupuncturist

Dr. Karl Yap-Sam, B.P.E., B.Ed., D.C.
Chiropractor, Acupuncturist, ART

Laura Darroch, B.Kin., RMT
Registered Massage Therapist

Post holiday stress getting to you? Stiff and tight? Stop putting it off, you can do something about it. Give yourself or the ones you care about the most important gift in the New Year. The gift of health. Here is a list of some of the services we provide at the Rouge River Chiropractic Clinic. We invite you to give us a call to find out if we can help. Wishing you all the best in the New Year.

Services Provided at RRCC

- Chiropractic Adjustments
- Acupuncture
- Registered Massage Therapy
- Custom Foot Orthotics
- Active Release Therapy

- Therapeutic Modalities: Laser, Ultrasound, IFC
- Exercise Prescription
- Sports Injuries
- Motor Vehicle Accidents/Workers Compensation Cases

Located At Altona & Kingston Rd. (HWY 2)

"I Prayed for a Miracle . . . I FOUND HYPNOSIS AND LOST 71 LBS.!"

My name is Marjorie Garst. I live with my husband John. I am a homemaker and mother of four. I volunteered as a foster mother for newborn babies. I lost a remarkable 71 pounds in eight short months without dieting. I went from a chubby size 20 to a trim size 10! This is my true-life account of genuine, lasting weight loss success.



Holding my fifth foster baby September 12, 1996 Before hypnosis

Now it's happened to me and I have my own true story to tell.

Embarrassed and Ashamed

I dreaded my yearly visits to the doctor. My weight was climbing at a rate of ten or more pounds a year. It was dangerous for me to gain weight. My blood pressure and cholesterol were sky high. My joints were stiff and ached constantly. I could barely lift myself out of a chair. My health was in jeopardy. Yet I couldn't stop eating. I was out of control.

I was a career snacker. I sat on the sofa, watched TV and ate. I sat at the kitchen table, read the newspaper and ate. When I fed my foster babies, I fed myself too. I lived on sweets and soda pop. Food seemed to have some mysterious power over me. I ate all day. With

every expansion of my hips and thighs my self-confidence withered. I was embarrassed, shy and reserved.

Dieting was the most confusing and frustrating experience of my life. Diets made me crave and binge. The only way I lost weight was by starving myself. I lost ten pounds once. Then I gave up and my weight came right back plus ten pounds more. My self-esteem was demolished.

Immediate Results

I was nervous when I called for the appointment. I didn't want to be pressured. The free hypnotic screening was a wonderful surprise. My consultant was genuinely interested in me. The high-pressure sales pitch never happened. She explained hypnosis in a relaxed, entertaining way. She went over the guarantee. I was impressed. If I couldn't be hypnotized, I would get a full refund. I had nothing to lose except a lot of fat. I signed up.

My new eating habits started immediately after my first session. My hunger pangs disappeared. My taste for soda pop vanished. I found myself craving healthy foods. Fruits and vegetables tasted different. It was like my taste buds came alive.

taste.

Doctor's Delight!
My last visit to my doctor was a thrill! My doctor nodded his head with delight. He confirmed my 71-pound weight loss. For the first time in my life my blood work and cholesterol are normal without pills!

I feel fantastic. No more aches and pains. No more cravings or binges. Best of all, hypnosis eliminated dieting for good!

Hypnosis made my weight loss easy and effortless. I know I will never gain the weight back. All the

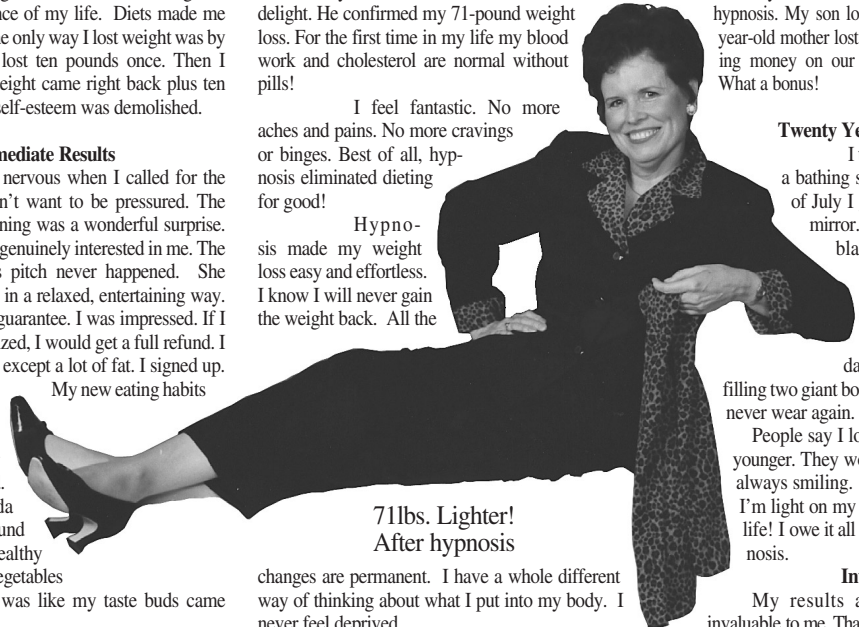

71lbs. Lighter!
After hypnosis

changes are permanent. I have a whole different way of thinking about what I put into my body. I never feel deprived.

Self-Confidence Soars!

When I was overweight I was extremely withdrawn. Some days I hardly spoke a word. I thought everyone was judging me. My self-worth was zero.

When the weight came off I felt better about myself. Hypnosis helped me relax. I gained a feeling of inner peace. I knew I was back in control of my life.

One Sunday my minister asked me to stand up in church to announce how much weight I had lost. After the service folks surrounded me to ask how I did it. I was completely comfortable chatting away with them. I couldn't believe it was me! So

relaxed! So confident! There are now seven members of our church using hypnosis. Including my husband, John! He's already lost 30 pounds!

My entire family has changed thanks to hypnosis. My son lost 22 pounds. My 83-year-old mother lost 18 pounds. We're saving money on our food bill every week. What a bonus!

Twenty Years Younger

I thought I'd never wear a bathing suit again. On the 4th of July I gazed at myself in the mirror. I was wearing a sexy black and purple one-piece suit. I loved what I saw! I wore it that day and many days since. The best day of my life was spent filling two giant boxes with fat clothes I'll never wear again.

People say I look twenty years younger. They wonder why I'm always smiling. I have tons of energy. I'm light on my feet. I have a social life! I owe it all to the power of hypnosis.

Invaluable!

My results at using hypnosis are invaluable to me. That's why I'm sharing my story with you. I believe in hypnosis. I'm certain you'll be as thrilled as I am. I know because I've met lots of other folks who are getting results like mine. They've shed 50, 60, even 90 pounds with ease.

Call Now and Schedule your hypnotic screening. It's absolutely free and there's no obligation. Ask about their no-risk guarantee. You'll be glad you did. If your evaluator doesn't think hypnosis is for you, she'll tell you so.

I know how much it hurts to be overweight. I've been there. If you have a weight problem, don't put it off. You'll probably just gain more weight. Do what I did. Call (Center name) at 000-0000. Hypnosis worked for me. It can work for you. Call now.



Positive Changes Hypnosis

Call now for your FREE Evaluation

725 Westney Road, S.
(at Finley) Suite 7, Ajax **905-686-7717**

Serving Satisfied Customers Since 1961 with Centers Worldwide





"Where results happen"

Book some deals, help Kidney Foundation

AJAX — Help support the Kidney Foundation of Canada this week while getting great deals from local businesses.

Until Thursday, Feb. 28, selected elementary and high schools in Ajax are selling 'The Durham Region Shopping and Savings Book'. Proceeds from the coupon book go towards Kidney Foundation of Canada services.

The book includes two-for-one dinner deals, free rounds of golf, savings on home decor, and children's activities. There is also an A to Z address book and a 2002 events calendar of Durham Region.

The price is \$20, including tax. Call Sheila Degerdon at 905-665-6600 for more information or to obtain a copy.

Durham group has plenty of stories to tell

DURHAM — Once upon a time, people told stories.

With that in mind, the Durham Folklore Society wants to help schools show students the oral tradition still exists today.

The society is providing all schools in the region and any other interested organizations with its 2002 directory of storytellers.

The booklet offers a brief biography of members who are accepting bookings and their contact address and

phone number for class or group functions.

The society is an umbrella forum for storytellers and those interested in learning about it. Members meet the fourth Thursday of each month at the Lovin' Oven, 65 King St. W. in Oshawa. They share stories and practice telling tales of culture, legends, family and more for people of all ages and walks of life. New members are always welcome.

The group's motto is 'come listen, come tell'. Storytellers are looking ahead to a Celtic celebration with storytelling, music and song to welcome spring. The event is March 16 at 8 p.m. in Town Hall 1873 on Queen and Simcoe streets in Port Perry.

For more information, phone artistic director Dianne Chandler at 905-985-3424.

For a directory or more information about the society, call Heather Whaley at 905-668-2174.

Altona Forest Public Meeting

The draft Altona Forest Trail Development and Management Plan forms an implementation component of the approved Altona Forest Environmental Management Plan (1996). The trial study provides a detailed plan to guide the development and management of trails, access points and related features within the forest.

The meeting will include:

- Altona Forest Overview Presentation
- Altona Forest Draft Trail Plan Presentation
- Altona Forest Stewardship Committee Presentation

Date: Wednesday, February 27, 2002

Time: 7:00 p.m. to 9:00 p.m.

Location: St. Elizabeth Seton School (auditorium)
490 Stroud Lane
Pickering, Ontario

If you would like to be kept informed of the public consultation process, provide input into the trail plan or be provided updates on the trail development, please call Mike Bender at (416) 661-6600, ext. 5287 or email: mbender@trca.on.ca.



Pucks For Bucks

YOU SHOOT.....YOU WIN!

"Pucks For Bucks" every day in February at the Great Blue Heron Charity Casino. Six exciting draws each day. You could win fabulous cash prizes. On Mondays and Tuesdays it all adds up, as you get an extra shot on goal.

SCORE BIG at the Great Blue Heron Charity Casino!

For more information, visit the Great Blue Heron Charity Casino or call 1-888-29 HERON.



We have a winner.

Port Perry, ON • www.greatblueheroncasino.com

450 Slots • 50 Gaming Tables

For contest rules and regulations, or for information on how to enter, visit our Rapid Rewards Players Club Centre. No purchase necessary. Must be 19 years of age or older. License #C000010. BAAGWATING COMMUNITY ASSOCIATION. Ontario Problem Gambling Helpline - 1-888-230-3505

SALE SPECIAL
BARGAINS
ADVERTISING FLYERS
IN TODAY'S
News Advertiser

Sunday, February 24, 2002 News Advertiser

- * A.O.L. Desk Ajax/Pickering
- * Fairport Guardian Drugs Pickering
- * Glenanna Guardian Drugs Pickering
- * No Frills Ajax/Pickering
- * Sun Win Chinese Restaurant Pickering
- * The Bay Ajax/Pick
- * Westney Guardian Drugs Ajax

* Delivered to selected households only
Remember, all inserts, including those on glossy paper, can be recycled with the rest of your newspaper through your blue box Recycling program. For information on delivering your advertising flyers, call DUNCAN FLETCHER at 683-5110.

Carrier of The Week



Jessica

Sunday's Carrier of the Week is Jessica. Jessica enjoys volleyball. She will receive a dinner for 4 voucher compliments of McDonald's.

Congratulations Jessica, for being our Carrier of the Week.



Walmart, 270 Kingston Rd. E., Ajax
Walmart, 1899 Brock Rd. N., Pick.
135 Kingston Rd., Ajax
222 Bayly St. W., Ajax
1360 Kingston Rd., Pick.

If you did not receive your News Advertiser or flyers call Circulation at 683-5117.

Hours: Mon. - Fri. 9 - 7:30
Sat. 9 - 4:30, Sun. 10 - 1

There's a little in everyone

Off-duty officer guilty of careless driving in death

BY STEPHEN SHAW
Staff Writer

DURHAM — A Durham Regional Police constable has pleaded guilty to careless driving in an off-duty collision that left a five-year-old boy dead.

Scott Airey, 26, a patrol officer working out of Oshawa's 17 Division, entered the plea to the Highway Traffic Act offence during an emotional hearing in a Lindsay courtroom Friday.

Evan Huntington, grandson of former Scugog public school board trustee Bobbie Drew, was killed Sept. 22, 2001 when the station wagon driven by his aunt, Janice Huntington, 49, of Port Perry, was rear-ended by the officer's Ford pickup truck on Kawartha Lakes Road 57, west of Janetville Road.

Court heard the station wagon was turning into a driveway when it was struck from behind by the officer's pickup, which was travelling at a speed of about 100 km/h. The car's turn signal was activated and it was at a near stop.

Evan, in senior kindergarten at Grandview Public School in Bethany, was in a rear-facing seat. Despite wearing his seat-belt, he was thrown from the car.

The family was on its way to the Lindsay Fair and was stopping to collect another relative at the time. The other occupants of the station wagon, including Evan's 10-year-old sister, Brittane, his grandmother Lois Huntington, and a cousin, Jeremy Wilcox, suffered various minor injuries.

Under a joint sentence proposal made by the Crown and defence, Const. Airey would receive a \$1,000 fine and one year's probation.

The proposed terms of probation include a ban on driving except while working as a police officer, performing 50 hours community service, attending 25 hours of counselling and participating in a "restorative justice meeting" with Evan's family members.

The exceptions to the driving ban

also include travelling to and from work.

Justice of the Peace Adele Romagnoli will hand down sentence April 5. Const. Airey is still on active duty.

Const. Airey, a Durham police officer for 18 months, was described as being emotionally devastated by the collision. He did not address the court during the hearing, attended by Evan's parents and other family members.

Instead, he has agreed to meet with the boy's relatives in person, said prosecutor Andrew Fordham, to allow both sides the opportunity to express their feelings.

"There is the belief he is extremely genuinely remorseful," said Mr. Fordham, adding there were many tears in the courtroom during the hearing, which included the reading of victim impact statements by Evan's relatives.

"It (the guilty plea) was a very emotional and tearful moment for all. This is a huge tragedy for everyone involved."

We Want
ITER

ITER - International Thermonuclear Experimental Reactor. The world is in dire need of cleaner, safer, more affordable energy - and an important solution may be "fusion research", which is the purpose of ITER.

WATCH FOR THIS SPECIAL SECTION IN YOUR METROLAND COMMUNITY NEWSPAPER FRIDAY, MARCH 1ST

Please recycle this paper



DON ARSENAULT
Would like to welcome his friends and past customers to visit him at his new location.

Menzies Chrysler 1602 Champlain Ave. Whitby
(905) 683-4100
(905) 576-1441

Dodge Jeep

MARCH 1-3, 2002
METRO EAST TRADE CENTRE
1899 BROCK RD., PICKERING, N. OF THE 401

Free Parking! **KEEPING 'YOUR BUSINESS' IN DURHAM!!**

FRIDAY: 2 admissions for the price of ONE

SATURDAY:
11:00 UNILOCK
Attend this do-it-yourself paver and retaining wall demonstration to receive your chance to **Win \$500** of Unilock product. FREE Design Guide.

1:00 & 3:00 with
Renee Montpellier, host of "The Decorating Challenge" will be respectively joined by Interior Designers Evelyn Eshun and Ellie Chollete. Create inexpensive custom table lamps and shades. Second show, colour washing and smoothing techniques.

2:00 ROGERS Home
"Surfing Techniques and Terminology" Search and get results! Demonstration followed by Q&A. Great Prizes to be won!

Win! **Trip for 2 to HAWAII!**
Round trip airfare Toronto to Honolulu 7 Nights at the Double Tree Waikiki from Paddy's Market in Hampton. Visit Goliger's at the show & enter to win! Draw at show, Sunday 4 p.m.!

SUNDAY:
12:00 UNILOCK
Attend this do-it-yourself paver and retaining wall demonstration to receive your chance to **Win \$500** of Unilock product. Pick-up your FREE Design Guide.

1:00 & 3:00 HGTV
Denis Flanagan, popular host of "Indoor Gardener" on HGTV and Landscape Designer on "The Decorating Challenge" for a fun and informative presentation on tuning up your garden for spring. Learn valuable tips and bring pictures and questions and receive some expert advice!

Win! Visit us at the show to enter. **LOTS OF PRIZES AND GIVEAWAYS!**
KX96 25" Zenith Colour TV from Paddy's Market in Hampton. Draw at show, Sunday 4:00 p.m.

Show Hours:
Friday, March 1/02: 11:00 am - 9 pm
Saturday, March 2/02: 10 am - 5 pm
Sunday, March 3/02: 10 am - 5 pm

Sponsored By: **ROGERS Home**, **TravelPlus**, **UNILOCK**, **Landscaping Ontario**, **COLUCCI POOLS**

brake service



25% OFF BRAKE PADS AND SHOES
when installed by Sears trained technicians

Service consists of complete inspection of your vehicle's braking system including pads, shoes, drums, rotors, master cylinders, calipers, wheel cylinders, hydraulic lines and emergency brake. Sears inspection and estimate will outline repairs required and make suggestions to maximize your vehicle's braking performance. #35011

only 19⁹⁹
Most vehicles

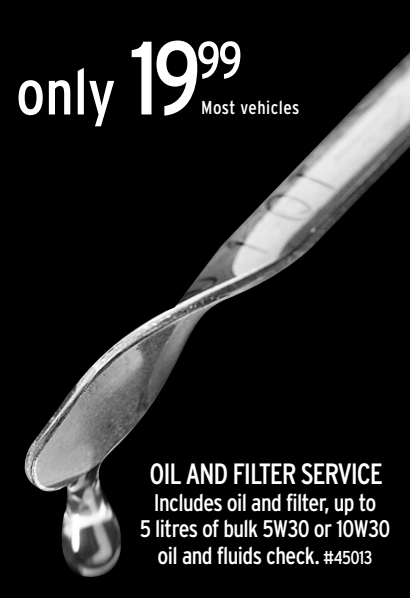

OIL AND FILTER SERVICE
Includes oil and filter, up to 5 litres of bulk 5W30 or 10W30 oil and fluids check. #45013

50% off
RESPONSE RST TOURING '2000' TIRES
Sale, from 55.99 each. P175/70R13. Other sizes, sale 59.49-91.49. #59000 series

*Complete warranty details at Sears



130,000 KM TREAD WEAROUT WARRANTY*

SEARS auto care™

SALE PRICES END SUN., MAR. 3, OR WHERE SEARS IS CLOSED, SAT., MAR. 2, 2002, WHILE QUANTITIES LAST

SEARS
ACCREDITED TEST AND REPAIR CENTRES
for more information call 1-888-758-2999
www.driveclean.com
Pickering Town Centre
Direct Line **420-0271**



NP0310502 Copyright 2002, Sears Canada Inc.

VISIT DURHAM REGION'S **Largest** GENUINE FACTORY OUTLET DURING RENOVATIONS &

SAVE BIG

Can You Imagine!

Sheets Flat Only
While Supplies Last

*Great for duvet covers,
curtains & more!*

Only **\$2.99**
Any Size

Over 5,000
Top Quality
Home Decor Products

**Check out our
incredible savings
during our renovations**

HOME DECOR



458 Fairall St., Ajax
(at Westney - across from GO Stn.)

Just South of 401
905.683.2222

Monday to Friday 9-8,
Saturday 9-6, Sunday 11-5

Canadian Manufacturer for 38 years

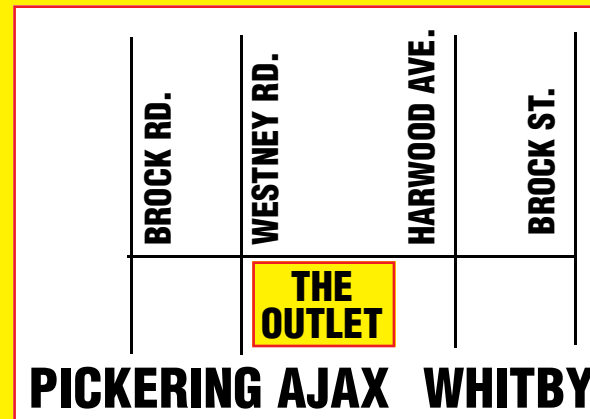

It's a FACTORY, It's a STORE...



**NO DOWN PAYMENT
NO PAYMENTS
NO INTEREST**

(GENERAL MOTORS PAYS THE INTEREST)*

PLUS

0%
Purchase
Financing
Up to
36 months*

on virtually all 2002 vehicles.



CHEVROLET IS THE PROUD SPONSOR OF
THE CANADIAN NATIONAL MEN'S AND WOMEN'S
HOCKEY TEAMS. CHEER THEM ON IN SALT LAKE CITY.



CHEVROLET CAVALIER VL COUPE OR SEDAN

DRIVE AWAY WITHOUT PAYING**		CASH PURCHASE PRICE
*0 Down Payment *0 1st Lease Payment *0 Security Deposit	\$226 per mo./48 mo. <small>INCLUDES FREIGHT</small>	\$12,498* <small>EXCLUDES FREIGHT</small>

**Administration fees and certain taxes may apply.
5-Year or 100,000 km Powertrain Warranty
 • 2.2 Litre 115-HP Engine • 5-Speed Getrag Transmission
 • 4-Wheel Anti-Lock Brakes • PASSLock Theft-Deterrent System
 • Electric Trunk Release • Dual Front Air Bags • Rear Spoiler (on Coupes only)



ALERO GX SEDAN BY OLDSMOBILE

DRIVE AWAY WITHOUT PAYING**		CASH PURCHASE PRICE
*0 Down Payment *0 1st Lease Payment *0 Security Deposit	\$314 per mo./48 mo. <small>INCLUDES FREIGHT</small>	\$19,998* <small>EXCLUDES FREIGHT</small>

**Administration fees and certain taxes may apply.
5-Year or 100,000 km Powertrain Warranty
 • 2.2 Litre DOHC All-New Ecotec Engine • Automatic Transmission with Enhanced Traction Control • Air Conditioning • AM/FM Stereo CD with 6-Speaker System
 • Cruise Control • Power Driver's Seat • 4-Wheel Disc Brakes with ABS • And More



CHEVROLET MALIBU

SMARTLEASE	CASH PURCHASE PRICE
\$248 per mo./48 mo. <small>\$2,675 Down Payment PLUS Freight & Security Deposit</small>	\$19,998* <small>EXCLUDES FREIGHT</small>

3.1 Litre 170-HP V6 Engine • 4-Speed Automatic Transmission
 • Air Conditioning • 60/40 Split-Folding Rear Seats
 • 4-Wheel Anti-Lock Brakes • Cruise Control • Remote Keyless Entry • AM/FM Stereo with CD • Power Door locks with Lockout Feature • Battery Run-Down Protection • PASSLock II Theft-Deterrent System • Stainless Steel Exhaust System
 • Power Windows/Mirrors



CHEVROLET VENTURE VALUE VAN

SMARTLEASE	CASH PURCHASE PRICE
\$238 per mo./48 mo. <small>\$3,720 Down Payment PLUS Freight & Security Deposit</small>	\$22,498* <small>EXCLUDES FREIGHT</small>

3.4 Litre 185-HP V6 Engine • 4-Speed Automatic Transmission • 4-Wheel Anti-Lock Brakes • Air Conditioning
 • Standard Integral Child Seat • Power Locks and Tilt-Wheel
 • AM/FM Stereo with CD • Dual Sliding Doors • 7-Passenger Seating with Flip-and-Fold Removable Seats • Canada's Best Fuel Economy



☆☆☆☆☆
 FIVE STAR SAFETY RATING. Chevrolet Venture has been awarded 5-Stars (the top safety rating) for frontal occupants in side-impact testing.¹



CHEVY TRAILBLAZER LS 4x4

SMARTLEASE	CASH PURCHASE PRICE
\$478 per mo./48 mo. <small>\$2,300 Down Payment PLUS Freight & Security Deposit</small>	\$35,998* <small>EXCLUDES FREIGHT</small>

4.2 Litre 270-HP Vortec In-line 6-Cylinder Engine • 4-Speed Automatic Transmission • Dual-Zone Air Conditioning • Autotrac Automatic AWD • Locking Differential • Side Impact Air Bags • 16" Aluminum Wheels • Power Locks/Windows/Heated Mirrors • Independent Front Suspension • 5-Link Rear Suspension • HD Trailering Equipment



CHEVY SILVERADO EXTENDED CAB

SMARTLEASE	CASH PURCHASE PRICE
\$358 per mo./36 mo. <small>\$3,720 Down Payment PLUS Freight & Security Deposit</small>	\$27,498* <small>EXCLUDES FREIGHT</small>

Vortec 4800 270-HP V8 Engine • 4-Speed Automatic Transmission with Overdrive and Tow/Haul Mode • 4-Wheel Disc & 4-Wheel Anti-Lock Braking system • 40/20/40 Split-Front Seat with Custom Cloth Trim • Air Conditioning with Interior Air Filtration System • AM/FM Stereo with CD • Chrome Grille • Full Instrumentation including: Tachometer, Engine Hourmeter and Driver Message Centre • Deep-Tinted Glass

Don't pay for 3 months, also available on other purchase finance rates for terms up to 60 months.

FOR A LIMITED TIME ONLY, AT YOUR LOCAL CHEVROLET • OLDSMOBILE DEALER.

FOR THE LATEST INFORMATION VISIT US AT gmcanada.com DROP BY YOUR LOCAL CHEVROLET • OLDSMOBILE DEALER, OR CALL US AT 1-800-GM-DRIVE.

**For 2002 Cavalier and 2002 Alero only. General Motors will pay first month's lease payment (including PST/GST as applicable) plus security deposit and PPSA. Freight of \$795/\$845 (Cavalier/Alero) included. Other lease options available. "Drive Away Lease" offer does not apply to purchase financing offer. *Based on a 2.9%/3.4%/3.4%/1.9%/5.4%/6.4% annual lease rate, 48/48/48/48/36-month term for Cavalier VL Coupe/Sedan R7A/Alero GX Sedan R7A/Malibu R7C/Venture Value Van R7A/TrailBlazer R7C/Silverado Ext. R7J. \$0.12/km charge over 60,000/80,000km for 36/48 months. Option to purchase at lease end is \$5,881/\$5,659/\$9,446/\$9,934/\$10,516/\$17,357/\$16,973 (Cavalier VL Coupe/Sedan R7A/Alero GX Sedan R7A/Malibu R7C/Venture Value Van R7A/TrailBlazer R7C/Silverado Ext. R7J) plus applicable taxes. Other lease options available. †Financing on approved GMAC credit only. Example: \$10,000 at 0% APR, the monthly payment is \$277.78 for 36 months. Cost of borrowing is \$0. Total Obligation is \$10,000. Down payment and/or trade may be required. Monthly payment and cost of borrowing will vary depending on amount borrowed and down payment/trade. ‡The SMARTLEASE monthly payment and the GMAC purchase finance rate are not available with and are not calculated on the "Cash Purchase" price as shown. The difference between the price for the SMARTLEASE/GMAC Purchase Finance offer and the "Cash Purchase" offer is deemed under provincial disclosure laws to be a cost of borrowing, whether or not the same represents actual interest and is required to be expressed as an annual percentage rate of 9.91%/4.76%/7.81%/5.61%/1.79%/4.61% (Cavalier VL Coupe/Sedan R7A/Alero GX Sedan R7A/Malibu R7C/Venture Value Van R7A/TrailBlazer R7C/Silverado Ext. R7J). *†Offers apply as indicated to new or demonstrator 2002 models of Cavalier VL Coupe/Sedan R7A/Alero GX Sedan R7A/Malibu R7C/Venture Value Van R7A/TrailBlazer R7C/Silverado Ext. R7J equipped as described. Offers apply to qualified retail customers in the Ontario Chevrolet Oldsmobile Dealer Marketing Association area only (including Outaouais and excluding Northwestern Ontario). Dealer order or trade may be necessary. Limited time offer that may not be combined with other offers. Lease and purchase offers do not include freight (\$845/\$995/\$875/\$1,000 for Malibu R7C/Venture Value Van R7A/TrailBlazer R7C/Silverado Ext. R7J), licence, insurance or taxes. Dealers are free to set individual prices. †Tests conducted by the US National Highway and Traffic Safety Administration (NHTSA). ‡Best in class. Based on Transport Canada Fuel Economy Ratings. †Offer applies only to vehicles delivered on or before April 1, 2002. Offer available on approved GMAC purchase financing up to 60 months (or only up to 36 months when combined with 0% purchase financing offer). ‡Don't pay for 3 months offer does not apply to 2001 model vehicles, 2002 Corvette, Full size vans-cargo/cutaway, Silverado Reg. and Ext. Cab 2500/3500 (non C6P), Silverado Crew Cab 2500/3500 and 3500 HD Chassis Cabs (Carryover Style), Chevy Express LT-Y91, Tahoe and Suburban. *††Dealers are free to set individual prices. Limited time offer that may not be combined with other offers. Certain exceptions apply. See your local Chevrolet Oldsmobile Dealer(s) for conditions and details.



City of

PICKERING
 Want to know what's happening in Pickering?
 Check Wednesday's paper each week for complete details
BE INFORMED!

Just the fax? 905-683-7363

Curves[®] for women
 "30 Minute Fitness & Weight Loss Centers"



Membership is honored at over 2000 Curves[®] locations in all 50 states, Canada & Europe!

Join Now
 * **60% Off** service fee

300 Kingston Rd.
 (Gates Plaza at Altona)
 905-509-5578

1050 Brock Rd.
 (between 401 & Bayly)
 905-421-9550

Fast • Fun • Fitness

Our Exclusive Quickfit Circuit...

- ✓ takes only 30 minutes
- ✓ burns body fat, not lean muscle
- ✓ strengthens muscles & cardiovascular system
- ✓ begins when you arrive
- ✓ is designed for women

CURVES[®] Weight Loss Program
 The first weight loss guidance program designed around exercise. *Permanent results without permanent dieting.*

*offer based on first visit enrollment. Min. 12 mo. c.d. program

DURHAM WINDOWS & DOORS
 SALES • SERVICE • INSTALLATION
 Complete selection of Vinyl Windows & Doors
MOBILE SHOWROOM
 TechWeld 2000
 Picture Windows
 Bay & Bow Windows
 Patio Doors • Casement Windows
 Wayne Hutchinson
 696 King St. W.
 Oshawa, ON
 (905) 579-2222
 1-888-576-8575

THRIFTY MECHANIC SHOP Inc.
 696 Finley Ave., Unit 1 & 2,
 Tel. 905-683-1112
 Proud to serve you

LUBE OIL & FILTER
\$18.95
ON MOST VEHICLES

FLUSH COOLING SYSTEM \$48.95
Check for details

DIAMOND SHINE

 CAR CLEANING & DETAILING
 Interior Shampoo Wax & Buff
 Vacuum & Wash
 (905) 619-2899
 221 Westney Rd. S.
 Unit C, Ajax, ON, L1S 2C9
 Gift Certificates for all occasions

Attention Home Owners!
SAVE HUNDREDS
Consolidate or Renegotiate
 • first time buyers • refinancing mortgages and debts
 • residential & commercial, transfers • power of sales
 • private and institutional funding • tax arrears

DIAMOND MORTGAGE Free Consultation
 416-739-6969

Durham Windows and Doors brings mobile showroom to your door

Wayne Hutchison brings to the replacement window and door business a new and long overdue feature. It's a Mobile Showroom which just may be the only one in Canada.

"The day is gone when you carried some brochures and a sample window to a customer's home," explains Wayne. "So I obtained a retired North York Mobile Library truck and installed interior walls along with all of my window samples."

When you call Durham Windows and Doors for a free estimate, Wayne will show up at your door with his Mobile Showroom which you'll enter by way of a sliding patio door.

Inside, displayed on the walls, are the Tech Weld 2000 series of vinyl windows which you're free to operate and you'll discover the many special features including how they can be cleaned without going outside.

"After being in this business for 24 years, I can honestly say these are

the finest windows on the market," says Wayne. "They're triple sealed to reduce air leakage and come with heavy duty hardware."

NO TAX IN FEBRUARY

All Tech Weld 2000 vinyl windows come with Low E Glass which filters out the ultraviolet rays keeping your home cooler in the summer and eliminate fading of your curtains, drapes and furniture.

All of the windows come with a lifetime warranty on the frame and hardware.

Wayne would also like his customers to know that he does all of the estimates personally, eliminating the cost of a salesperson.

Durham Windows and Doors



Top, Wayne Hutchison will bring his Mobile Showroom to your home. Above, inside you'll find his display of Top Quality Vinyl Windows.

also does all of its own installations, which ensures that every customer gets a high quality job done at the best possible price.

Durham Windows and Doors is located at 696 King St. W. in Oshawa. For more information call (905) 579-2222 or 1-888-576-8575.

From 5.7% for 5 years.
1st & 2nd Mortgages to 100%
CENTRAL FUNDING GROUP
 Condos
 Rental Properties
 "BEST AVAILABLE RATES"
 "PRIVATE FUNDS AVAILABLE"
 Refinancing debt consolidation a specialty
 For FAST PROFESSIONAL SERVICE
 CALL (905) 686-2557

Plumbing III Mart
 FREE in Home Estimates
 FOR KITCHEN & BATHROOM RENOVATIONS
 HUGE RENOVATION SHOWROOM
 KITCHEN & BATHROOM MODELS
 CUSTOM UPGRADES INCLUDED WITH ALL RENOVATION PROJECTS
 BOOKED THIS MONTH!
1-888-BATH-RENO
416-285-6798

CANADIAN ASSOCIATION OF INSURANCE AND FINANCIAL ADVISORS
CAIFA DURHAM REGION
Whose advice are you taking?
 Call 1-800-563-5822

THREE BEARS AUTO BODY
 "ONE OF DURHAM'S LARGEST AUTO BODY & COLLISION SHOPS"
 "Serving The Durham Region" Free Estimates!
\$200 Towards Insurance Deductible (with this ad)
 Offer expires February 28, 2002
 *Coupon must be presented prior to work being started
 UNIT #20B, 282 MONARCH AVE., AJAX
 (905) 619-2327
*Some restrictions apply. Ask for details.

To advertise in this feature
 Please call
905-683-0707
 ext. 2303, 2334, 2304

F O C U S O N B U S I N E S S P I C K E R I N G

Name Dropping

NEWS ADVERTISER FEB. 24, 2002

Birthday

One of the cuties in the Gilligan clan is two. **Kaitlyn** celebrated her birthday Jan. 19 and she had a lot of fun at her party. Wishing Kaitlyn a happy birthday were sisters **Sydney, Amy, Melissa** and **Rebecca**, **Mommy** and **Poppa**, **Grandma** and **Granddad Gilligan**, **Grandma** and **Grandpa Martin**, cousins **Matt, Mike** and **Geoff**, **Aunt Lynne**, **Uncles Sean, Keith** and **Allan**, feline friends **Muffin, Buddy** and **Wolf**, and **Grady** the dog.

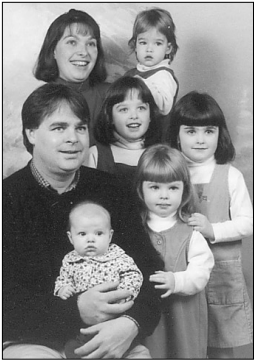

Birthday

Feb. 11 was a special day at the **Staines** residence. "Our special girl" **Monica** turned four. Happy birthday and love from **Mommy, Daddy, Kevin, Nick Nick** and **Buddy**.

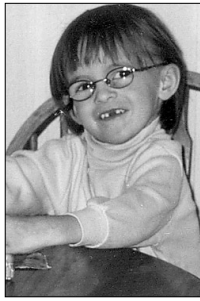

Birthday

"Delightful **Karen Jeffrey** was eight Feb. 11. We are all so proud of you. Love from **Mom Denyse, Step-Dad Gary** and **Dad Ron**."



Birthday

"Happy birthday to **Christopher James Leinwand**. We love you very much. Love **Daddy** and **Mommy** and all your family and friends."



Birthday

Happy 14th birthday wishes went out to **Jessie Kassen** on Feb. 14. "Best wishes on your special day! Have fun, love from **Dan** and **Lindsay**."

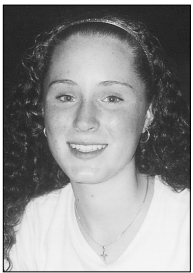

Birthday

A birthday poem for "our wee **Rabbie**:
He's five
And fully alive,
Kindermusik he loves
Karate and hockey too.
He can dive 'n' jive.
What a sight in his kilt
Like Braveheart he's built.
Our Robert, our treasure,
Sure gives us much pleasure.
Happy fifth birthday, dearest son and grandson. **Robert** celebrated his special day with his wee pals at Chuck E Cheese. Also wishing him all the best were his **Mom, Dad, Grandma** and **Grandpa McCaughey, Nonna** and **Nonno Colasuonno**, the **Smith** clan and **Great Auntie Claire** in bonnie Scotland."

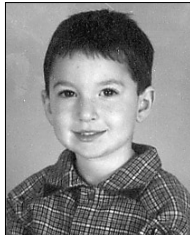

Engagement

Gail and Don Chapman of Pickering are happy to announce the engagement of their daughter **Carrie to Patrick Middleton**. Pat is the son of **Doreen** and **Bruce Middleton**, also of Pickering. The couple have been engaged since November and will be married in June.

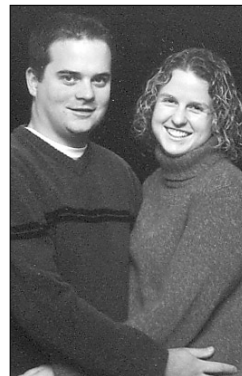

Birthday

Alison Jones turned 18 Feb. 8. There are happy birthday wishes and love from **Mom, Dad** and **Adrienne**.



Birthday

A happy birthday message for **Reese** on Feb. 14. "It happened so fast, you're already two. We treasure each moment enjoyed with you. Lots of love from **Mama** and **Dada**."

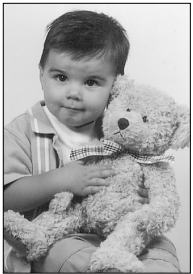

Birthday

There are happy eighth birthday wishes going out to a slugger. Love, hugs and kisses for **Kevin** come from **Mom, Dad, Brent, Gramma** and **No-No**.



Birthday

"Wow! It's that time of year again. On Feb. 9, **Brandon Pryce** celebrated his eighth birthday. Our little Cujo has had an amazing year and we wish him all the best for the upcoming year. Good luck and best wishes. Love from **Mom, Dad, Shawntai, Trey, Amy, Daniel, Dante, Kris** and the rest of your proud family."

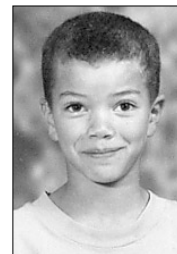

Birthday

"Our little princess is seven! **Lauren McCarthy** turned seven Feb. 4. Have a good time bowling and at your craft party. Have fun in Virginia Beach. Love you lots from **Mommy, Daddy**, sister **Megan**, grandparents, aunts, uncles and cousins."

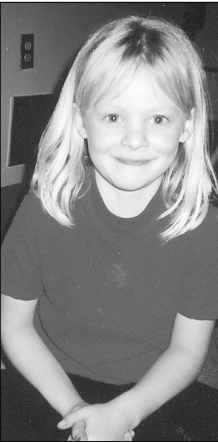

Birthday

On Feb. 17, **Ashleen Grange** turned eight. There's lots of love to "our birthday girl" from **Mommy, Daddy** and **Elise**.



Birthday



"It's fine to be nine," says **Jordan Kotsopoulos**, as he celebrated his birthday Feb. 19. Wishing Jordan a happy birthday were **Mom, Dad, Alex, Tyler, Joshua** and **Victoria**.

Birthday



"**Emma Faren Mahroo** turned five Feb. 10. Happy birthday darling Emma Joon from **Mommy, Daddy** and **Julia**. Best wishes from **Maman, Granny, Fedra, Daie, Khale Minoo**, your uncles, cousins, **Baba** and **Arthur**."

Birthday

Happy birthday to "our little hockey superstar", **Nicholas William Sribny**, who turned three Feb. 16. "We are so proud of you and love you very much. Have a wonderful time at your party with all of your family and friends. Love and lots of hugs and kisses from **Mommy, Daddy, Cassandra, Alexia**, family and friends."

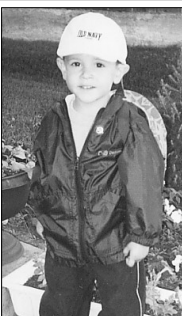

Birthday

Feb. 16 was a big day for **Jesse Joseph Chafe**, as he turned nine. There was love, hugs and kisses from **Mom, Dan** and **Skyball**.

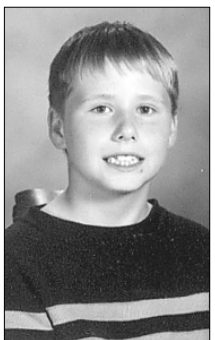

Birthday

"Our first born son turned nine Feb. 20. Happy birthday **Jerrod**. You are a wonderful child and we love you very much. May God continue to fill you with wisdom, knowledge and understanding. This little light of mine I'm going to let it shine! Love from **Mom, Dad** and **Jaylan**."

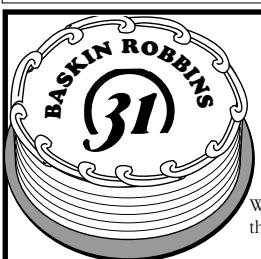
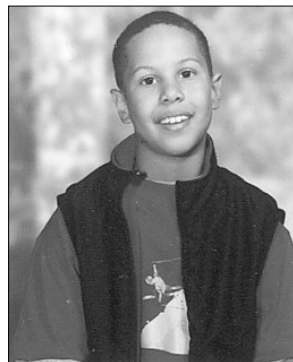

1794 Liverpool Road
Pickering 905-831-5431

THIS WEEK'S CAKE WINNERS ARE:

1. Lauren McCarthy
2. Brandon Pryce
3. Ashleen Grange

Winners may go directly to Baskin Robbins to receive their FREE cake. (Please provide identification)

PRIZE VALID UNTIL SAT., MARCH 2, 2002

*Birthday? Anniversary? Wedding?
Let us know. We'll publish your
special occasion in an easy-to-read
and easy-to-clip format...*

*...Send to:
Name Dropping,
c/o Keith Gilligan,
130 Commercial Ave.,
Ajax, Ont. L1S 2H5*

Gray day perfect for Panthers

Goalie shines in Pickering's series-clinching win over Thornhill Rattlers

BY AL RIVETT
Sports Editor



SCOTT GRAY
Backstops Panthers to victory over Thornhill in Game 7.

Panthers in control of the pivotal contest. After allowing a fluke first-period marker knocked in by a Pickering player, goaltender Scott Gray was superb through the remainder of the contest, including stoning the Rattlers in the third period. The Panthers scored an empty-net marker late in the game.

The Panthers' top forward combination of team captain Garret Winder, Dan Schofield and Mike Hanna also came to the fore in the pivotal contest, scoring three of the five goals.

But, it was Gray's brilliance in making 28 saves that keyed the victory for the Panthers, noted head coach Bill Purcell.

"Gray was outstanding. The only goal they scored was one our defencemen put in our own net. He's a kid who comes to play," he said. "To me, he's a gamer. When he gets beaten he gets damn angry about it. I like a lot of his traits."

For the Panthers, it was their first time advancing beyond the first round of the playoffs in three years.

Pickering was the clear underdog in the series, noted Purcell, playing the fourth-place Rattlers who not only boasted home-ice advantage in the series, but also entered the playoffs as the defending league champions. Pickering finished the season in fifth place, one point back.

"We were supposed to lose four straight," said Purcell. "I think it's the biggest upset of all the (first-round) playoff series. They were a team that won the league championship last year and went to the Canadian championships. They are a team with a big payroll. It's definitely the biggest upset."

Hanna, Schofield, Mike Alexiou, Alex Greig and Winder, into an empty net, scored.

Assisting were Winder and Hanna each with two, Schofield, Kyle Aitken, Colin Jennings, Ryan Taylor, Paul McFarland and Gray.

Purcell said he has no preference as to which team (Wexford or St. Michael's) his Panthers will play in the conference semifinal series.

"You're playing the best teams at this stage, so it doesn't matter."

PANTHERS' POSTSCRIPT: Purcell said he was impressed with the quality of officiating in the contest. "It wouldn't have mattered if we had won or lost, the guy knew how to handle a game...A large number of Panthers' fans turned out for Thursday's game.

PICKERING — A pumped up Pickering Boyer Pontiac Panthers team is moving on, while the defending league champion Thornhill Rattlers are toast following a seventh and deciding playoff game Thursday night.

The Panthers received big contributions from the entire roster to post a convincing 5-1 victory over Thornhill in Game 7 of the OHA Ontario Provincial Junior 'A' Hockey League South Conference opening-round playoff series. The game was played on neutral ice at the Beatrice Ice Gardens at York University after ice couldn't be secured at the Rattlers' home rink, the Thornhill Community Centre.

The Panthers will face either the first-place Wexford Raiders or the second-place St. Michael's Buzzers in the conference semifinal series pending the outcome of Game 7 in the Markham-North York series Friday (the result wasn't available at the News Advertiser's deadline). A Markham win means the Panthers play Wexford,

while a North York win means Pickering will suit up against St. Mike's. A big four-goal second period put the

SCOREBOARD

PICKERING MEN'S BASKETBALL LEAGUE
Round-robin playoff action
GAME ONE
Gallantry's Eatery 51 vs. Verifeye 51 (overtime tie)
TOP SCORERS
Gallantry's Eatery: John Christiansen 24, Bob Pfizer 14, Tom Parisi 7.
Verifeye: David Voth 14, Don Thompson 10, Steve Holmes 7, Frank Forde 7.

GAME TWO
Eil-Rod Holdings 51 vs. West Hill Men's Slo-Pitch 34.
TOP SCORERS
Eil-Rod Holdings: Mike Horn 16, Dave Bayliss 10, Carl Sassman 6, Al Sakata 6.
West Hill Men's Slo-Pitch: Glenn Hill 10, George Iordanov 8, Charlie Denchfield 7, Rod Fraser 7.

GAME THREE
Envoy Business Services 65 vs. Van Kempen Insurance 34.
TOP SCORERS
Envoy Business Services: Pat Roach 15, Randy Filinski 14, Roger Young 12, Jim Wilkinson 8.
Van Kempen Insurance: Horace Peterkin 8, Kip Van Kem-

pen 8, Ray Fox 6, Irwin Stanley 6.
GAME FOUR
Mud Hen's 45 vs. Melanie Pringles 32.
TOP SCORERS
Mud Hen's: Ivor Walker 13, Fred Dever 9, Don Leahy 9, Luke Lukkonen 5.
Melanie Pringles: Karl Hutchinson 20, Ron Pella 4.

WE CAN HELP YOU
ACHIEVE A FRESH START
Professional and Personalized Service
Free Confidential Consultation
CLARKE HENNING INC.
Trustees in Bankruptcy

Several convenient locations, including:

OSHAWA 146 Simcoe Street N. (Downtown)	(905) 728-9404
SCARBOROUGH 1919 Lawrence Ave. E. (near DVP and 401)	(416) 750-9620
255 Morningside Ave. (Morningside Mall)	(416) 283-8140

ALL SEASONS DRIVING SCHOOL
MTO & OSO APPROVED
March Break Specials
4 day courses
March 11, 12, 13, 14/2002
Daytime - 9 a.m.-3:30 p.m.
Evening - 4 p.m.-10:30 p.m.

- 25 Hours of In-class • 15 In-car lessons
- INSURANCE DISCOUNT CERTIFICATE
- Group discounts (3 or more)
- Installment Payment Plan Available
- Mini Package - 6 lessons & road test \$149.00

905-420-8641
924 Kingston Rd., Pickering (Above City Cleaners)

Warren's Glen
Oakridge's New State-of-the-Art,
4-Season Practice Centre

Grand Opening
March 10, 2002

4km. south of Utica, 4kms. north of Ashburn off Ashburn Road.
OR...11km north of Hwy 7 on Ashburn Road, follow the signs.

(905) 985-8390

Men's Accountability Team
Presents
Business Planning For Success
Strategic Planning

Guest Speaker
Mark Rivers
Founder and President of P.E.O. Presidents of Entrepreneurial Organizations
Mark is the author of "Designed To Win, Built To Make A Difference", a principle based leadership development program.

- Vision • Theory of Constraints
- Implementation • Plan for Success
- Being Honest

"SHARING IDEAS FOR SUCCESS"

Faith Family Church
75 Chambers Drive, Unit #2,
Ajax, Ontario, L1Z 1E1
Phone: 905-619-1109

Saturday
March 2, 2002
@ 8 a.m.

GOLF BARRIE Free!

The first 8,000 visitors at the Toronto Star Golf & Travel Show on Friday, March 1, 2002 will receive **ONE FREE ROUND OF GOLF** from one of Barrie's participating courses, including:

Bear Creek Golf Club • Bonaire Golf Club
Innisbrook Golf Course • National Pines Golf Club
Shanty Bay Golf Club • Simoro Golf Links
Springwater Golf Course • Tangle Creek Golf Club

Plus, enter for a chance to **WIN A FREE WEEKEND GOLF PACKAGE** courtesy of **BARRIE**

Hotel Partners:
Comfort Inn on Hart Drive • Holiday Inn Barrie
Travelodge Barrie on Hart Drive
Travelodge Barrie on Bayfield Street

THE TORONTO STAR GOLF & TRAVEL SHOW
Presented by **ACURA**
FEB. 28 - MARCH 3, 2002
South Building
Metro Toronto Convention Centre
For information: 905-815-0017 (ext. 305)

Sponsored by: DIMARCO GOLF, CLUBLINK, PGA MERIT, PIZZA PIZZA, the DOORS, MOOSEHEAD, Global, FAN 590, MetroLink.

Ajax-Pickering News Advertiser CLASSIFIEDS



To Place Your Ad In Ajax or Pickering Call:

905-683-0707

E-Mail address: classifieds@durhamregion.com

Web Site: www.durhamregion.com

"TECS" - Training • Education • Careers • Schooling "TECS" - Training • Education • Careers • Schooling

505 Careers **505** Careers **505** Careers

**Begin your new career in
ESTHETICS and SALON OPERATIONS
with a diploma from
THE TORONTO SCHOOL OF BUSINESS**

Training includes:

- Manicures/Pedicures
- Facials
- Make-up
- Aromatherapy
- Client Consultation
- Salon Operations/Computers
- Skin Treatments
- Hair Removal/Waxing
- Body Treatments/Aromatherapy
- Body Massage/Reflexology
- Professional Skills/Jobsearch



**Call for class information.
Seats are limited!**

Financial assistance may be available to qualified candidates.

TORONTO School of Business Pickering Campus
1450 Kingston Rd. Pickering
(905) 420-1344

Helping You Build a Better Life

Other Classes Starting Soon:

- | | |
|----------------------------|------------------------|
| Accounting & Payroll Admin | Small Business Manager |
| I.T. Technician | Network Administrator |
| Personal Support Worker | Web Design/E-commerce |
| Exec. Office Assistant | Legal Admin. Assistant |

505 Careers **505** Careers

CAREER SEMINAR Reserve your seat today!

Freedom 55 Financial invites you to an introductory seminar to see if a career in financial services is right for you. Nine-week paid training program for suitable candidates.



Wed. Feb. 27, 2002
2:00 p.m. or 6:30 p.m.
95 Bayly, 5th Floor, Ajax
(905) 427-5800 ext. 230

Freedom 55 Financial and design are trademarks of London Life Insurance Company.

quantum
We put our energy to work for you!



We are currently hiring for the following temporary positions:

Industrial Positions:

- Strong Labourers up to 50 lbs (\$9.45/hr)
- Assemblers (\$7.50/hr)
- Male and Female Picker/Packers (\$7.50/hr +)
- Shipper/Receivers (\$10.00/hr)
- Exp. Forklift Operators (\$10.00/hr +)
- Exp. Welders (\$12.00/hr)
- Semi-skilled Machine Operators (\$8.00/hr +)
- Semi-skilled Labourers (\$8.50/hr +)
- Skilled Machine Operators (\$11.00/hr +)

Bring a friend and ask about our referral bonus!

Please bring your resume.

Walk in to Quantum Management Services
Monday to Friday 9:00 am to 3:00 pm
305 Milner Ave., Suite 311
Scarborough, Ontario
(corner of Markham Rd. & Milner Ave.)
Bring a void cheque and find out about our
Direct Deposit Program
or
Meet us at the Pickering Rec Complex- Room #3
Tuesday, February 26th, 2002 1:00 pm to 3:30 pm
1867 Valley Farm Rd (off Hwy 2)
Pickering, Ontario

BROKER / CSR

Established & Growing Durham Insurance Broker
Has a position available for R.I.B.O. Licensed Broker as Personal Lines/Producer. Cantonese/Mandarin language an asset. Fax info/resume to: Laura -905-427-4615

SPANISH Language COURSES
Speak It With Fluency

- Total Immersion Daytime Courses
- Evening Courses
- College/University Students Welcome

(905) 720-3957
www.tolearnspanish.com
Oshawa

500 Career Training

CANADIAN FLORAL ACADEMY now offers you a three-week training program in the floral industry. Complete training in business, marketing and job skills. Enroll now! Call 905-436-7746.

505 Careers

ONTARIO MANAGEMENT DEVELOPMENT PROGRAM at Durham College. Advance your position with leadership skills and management skills training - certificate program. The skills businesses are looking for. \$162.40 per course. Call Colin McCarthy 905-721-3336.

505 Careers **505** Careers **505** Careers

BE A YOUNG Entrepreneur



If you're curious about business or ready to start one, Business Bound can help! See if self-employment is for you and explore next steps in our **FREE INFO SESSION:**

Feb 28th, 7 - 8 pm
Whitby Station Gallery
(across from Iroquois Sports Centre, behind Whitby GO)

Mar 7th, 7 - 8 pm
Pickering Public Library
(beside the Pickering Town Centre)

Visit www.bizbound.ca for more info.



VON CANADA

FINANCE MANAGER
(P-T 22.5 HRS/WK)

SHORT TERM CONTRACT - 6 MO.

Responsibilities: Month end/year end reporting and analysis, maintenance /review of internal controls, cash flow management/budgeting, guidance to externally funded programs, audit preparation.
Qualifications: CMA/CGA/CA or 4th/5th level in a recognized accounting program with 3 - 5 years extensive accounting experience in a decision making capacity.

Submit resumes by March 1st, 2002 to:
HR Manager - Victorian Order of Nurses
223 Brock St. N., Whitby, Ontario L1N 4H6
Fax (905) 665-2333

Email: vondurham@look.ca

Only those selected for an interview will be contacted.



There's a career in your future!
Account Executives

Household Financial Corporation Limited is please to offer exciting opportunities to join our branch network. We are looking for energetic, motivated, self-starters who are eager to apply themselves within a fast paced environment. If you are ambitious, customer focused and have sales experience with a positive attitude, you are the candidate we are seeking.

We offer a competitive salary, an exceptional benefit package, monthly incentives and excellent career opportunities. A comprehensive training program is provided. Opportunities are available in our Pickering & Oshawa branches.

Interested in joining our team? Send resume by fax to:
Laurie Ernst, Branch Sales Manager
Fax: 905-420-4479

We wish to thank all applicants for their interest, however, only those selected for an interview will be contacted

510 General Help

WORK AT HOME Health Industry \$1000 P/T - \$5000 F/T per month. Training available. Call for free information BOOKLET. 416-631-7156. or www.workathomevc.com

FRESH AIR, exercise and more. Call for a carrier route in your area today. 905-683-5117.

510 General Help

FULL-TIME QUALIFIED ECE'S required. Bring resume in person to: MY SCHOOL, (s/w corner Lakeridge & Hwy. 7)

EXPERIENCED PIZZA maker required. Full-time position, mostly days. Call Matt after 6pm (905)427-7257

510 General Help

EXPERIENCED TELEMARKETER needed. Please call (905)427-6040

EARN UP TO \$2000/month working from home. Full training provided. Call 1-888-212-8971 or visit www.lots2send.com

510 General Help

ATTENTION ALL UNEMPLOYED!! Tired of the round? Can't get a job b/lack exp? Can't get exp because you can't get a job you are available for full time start immediately as Joey 905-435-0730

APPOINTMENT SETTERS REQUIRED IMMEDIATELY
Days & Evening Full & Part-time Earn up to \$16/h No Selling Call for interview (905)426-1322

ACCESS TO A COMPUTER Work from home on \$1500-\$3500 PT/FT, log on www.ezglobalincome.com toll free 1-888-563-3617

ACCESS TO A COMPUTER Work at home online. \$25/hour, part-time, full-time. www.onaroll2dreams.com 800-311-5782

ARE YOU CONNECTED? Learn how to earn online! www.homemakers.com

PROFESSIONAL EXPERIENCE NECESSARY- Full-time needed for busy grooming salon. Suits young, active son. Please call Pawf Dog Salon at 905-420-5343

CLASSIFIED CUSTOMER SERVICE

News Advertiser requests that advertisers check their ad up publication as News Advertiser will not be responsible for more than one incorrect insert and there shall be no liability for non-insert of any advertisement. Liability for errors in is limited to the amount paid for the space occupying the error. All is subject to the approval of management News Advertiser.

COURIER DRIVERS with can earn up to \$650+/w/ With vans can earn up to \$1000+/weekly servicing ham and GTA. (905)427-80

CUSTOMER SERVICE ORDER TAKERS required

\$21.00/hr average
24 positions available Full training provided
Call Brian
905-435-1052

TELEMARKETERS require major national company selling, flexible hours. experience an asset. These situations offer excellent potential. Call Sid @ 905 2022 or fax resume to 428-2452

DZ DRIVER WANTED for distribution company must household/home delivery experience. Clean abstract/er and 2 men crews also comed. Fax resume 416 9480

G CLASS DRIVERS require customer service skills, to lift & deliver 40lb. call valid g class drivers license driving record (abs required). GTA experience must, potential earning 1 on piece work and/or per age. Please fax resume (416)292-9480

HELP WANTED. Is your account running on empty? Fill 'er up! Call Joe at 576-5523

HOMEMAKERS part evening & Saturday marketing positions available. \$8.00/hour. Call between 1pm & 8pm to arrange a interview. 905-619-6991

Would you like an exciting career as a
POLICE OFFICER

Take the Police Foundations Training course with the only specialized College in Ontario exclusively dedicated to Police studies. Get the most effective and shortest possible training with the best instructors.

Corrections, Customs, Court Officers

Police Foundations Department

Of Diamond Institute Of Business

1-866-5-POLICE



Celebrating our 20th successful year.
Website: www.policefoundations-cbc.com

Proud members of the Ont. Association of Chiefs of Police

FAMILY COMMUNITY ACTION PROGRAM, DURHAM REGION

Community Facilitator

The Family & Community Action Program of Durham Region servicing families with children ages 0-6 yrs. invites applicants for the position of Community Facilitator.

This position includes community development, ongoing support of parent groups, and supervision of home visitors. Demonstrated experience working with families and facilitation of parent groups. Knowledge of support services available for children 0-6 yrs. in Durham Region. Degree in the human services field or a combination of relevant education and experience. Must have a valid Ontario drivers license and automobile.

Please send cover letter & resume by mail or fax by to: March 1st, 2002.

FCAP Hiring Committee
Family & Community Action Program/YMCA
230 Westney Road South
Ajax, ON, L1S 7J5
Fax: (905) 619-4578

Only those individuals chosen for an interview will be notified.

Ajax Pickering News Advertiser
130 Commercial Ave., Ajax
Hours: Mon.-Fri 8:00-5 p.m.
Closed Saturday



Our phone lines are open Mon. to Fri. until 8 p.m.

Classified Online: Now when you advertise, your word ad also appears on the internet at <http://www.durhamregion.com>
Email: compose@durhamregion.com

Toronto Line: (416) 798-7259
24-Hour Fax: (905) 579-4218

510 General Help **510** General Help

Whitby Manufacturer of Steel Storage Equipment requires a hands-on PLANT ENGINEER
 Mechanical or Civil Engineering Degree. Responsible for Plant and Maintenance Dept. with an interest in CAD layouts, metal fabricating equipment and tool and die. Proficient in AutoCad and Excel.
 Send resume (complete with references) to:
NORTH AMERICAN STEEL
300 Hopkins Street
Whitby, Ontario. L1N 2B9
e-mail: sales@naseco.ca
Fax (905) 668-5477

GARDEN BASKET
 FOOD MARKETS
 Quality & Freshness Since 1929

HELP WANTED
 FULL TIME POSITIONS AVAILABLE FOR
MEAT CUTTERS,
MEAT WRAPPERS,
GROCERY CLERKS, PRODUCE
CLERKS, DAIRY CLERKS AND
RECEIVER/SHIPPERS
 Excellent Pay and Benefits
 Immediate Employment

ALSO, PART-TIME POSITIONS
AVAILABLE IN ALL DEPARTMENTS.
 Apply in person at **THE GARDEN BASKET**
9275 Markham Road (at 16th Ave.)
Or Fax RESUME TO: 905-471-0922
 We appreciate all responses, but regret that only those selected for an interview will be contacted.

The News Advertiser
 Is looking for reliable people to insert and deliver papers and flyers door to door every Wednesday, Friday and Saturday in the Pickering area. Deliveries must be completed by 6:00 pm. Must have a vehicle. For more information call **905-683-5117**

WORKERS NEEDED
 18 and older
 Expanding company needs to fill positions yesterday. We are ahead of production and behind on good people. Excellent training. \$1600.00/month to start
Call Fri, Sat. 12-5pm, Mon (905)434-6149

MUSIC TEACHERS
 Required with car. Minimum Grade 8 practical, Grade 2 Theory (or equivalent) Vocal and all instruments. Flexible hours. Please email resume to:
learnmusic@home.com
 or call (905) 721-9799

SHIPPER/RECEIVER
 required for busy hi-tech company. Good organizational skills and computer knowledge required. Email resume to:
CARDAC@KEYSCAN.CA

TEACHERS REQUIRED
 P/T tutoring contracts avail. Must have OTC, EA, related degree or equiv. experience. Fax resume to: 905-728-1033 Email: admin@learningbound.ca

THE NEWS ADVERTISER
 Is looking for carriers to deliver papers and flyers door to door Wed. Fri. & Sat. by 6:00 PM. in their neighborhoods. call **905-683-5117**

510 General Help **510** General Help

THE NEWS ADVERTISER
 is looking for prospects to deliver newspapers & flyers to the following areas
 ☆☆☆☆☆☆
AJAX
 130 & 120 Old Kingston Rd.
 Tawn Cres. Trowell Ln.
 Ingold Ln. Booth Cres.
 Old Harwood Ave. Parker Cres.
 Harridan Ln. Patience Ln.
 Dryer Dr.E. Lambard Cres.
 Farley Cir. Harland Cres.
 Anstead Cres, Finley Ave.
 Cadby Rd. Clements Rd.E.
 Strathy Rd. Turnbull Rd.
 Simpson Rd. Follett Cr.
 Emperor St. Burcher Rd.
 Tulloch Dr. Warick Ave.

PICKERING
 1310 Fieldlight Blvd
 1331 & 13350 Glenanna Rd.
 Everton St. 1975 Memory
 Faylee Cres. 1990 Whites
 Amberlea Rd. Nipissing Cr.
 Napanee Rd. Otonabee Dr.
 Seguin Sq. Eramosa Cres.
 Highview Rd., Sultana Sq.
 Norfolk Sq. Foxwood Trail
 Flavelle Cr. Wildwood Cres.
 Gardenview Sq. Beckworth Sq.
 Amberwood Craighurst crt.
 Graceland Cr. Krosno Blvd.
 Alyssum St. Lublin Ave.
 Reytan Blvd. Modlin Rd.
 Garvolin Ave. Zator ave.
 Benm Ave. Antonio St.
 Fiddlers Cr. Old Forest Rd.
 Autumn Cres. White Cedar Dr.
 Silver Maple Dr. Sandcherry Cr.
 Sandhurst Cres. Pinegrove ave.
 Wildflower Dr. Summerpark
 Valley Ridge Waterford Gate
 Westcreek Dr. Rouge Forest
 Breezy Dr. Mink St.
 Toynvale Rd. Charnwood Cr.
 Dencourt Dr. Sheppard Ave

FOR FURTHER INFORMATION
OR FOR ROUTES AVAILABLE IN
YOUR AREA PLEASE CALL
905-683-5117

CONFIDENTIAL TO BOX REPLIES
 If there are firms or individuals to whom you do not wish your reply sent, simply place your application in an envelope addressed to the box number in the advertisement and attach a list of such names. Place your application and list in an envelope and address to: Box Replies. If the advertiser is one of the names on your list your application will be destroyed.
PLEASE NOTE, resumes that are faxed directly to Oshawa This Week, will not be forwarded to the file number. Originals must be sent directly as indicated by the instructions in the ad.

FORCED TO HIRE
\$22.00/HR
 OSHAWA DISTRIBUTION CO. REQUIRES 15 PEOPLE IN SET-UP AND DISPLAY DEPT.
 • **ADVANCEMENT FOR FAST LEARNERS.**
 • **MUST HAVE OWN CAR**
 • **OVER 18-ABLE TO START IMMED.**
 • **NO EXPERIENCE**
 • **FULL-TIME AND PART TIME**
 For Interview Call
MON-TUES ONLY - 10AM-5PM
905-720-1507

TIRECRAFT COMMERCIAL (ONT.) INC.
 Ontario's largest independent tire sales and manufacturing company is growing and requires an additional staff member in our Oshawa location for the following position:
CERTIFIED TRUCK TIRE SERVICEPERSON
 Preference will be given to the person with a positive attitude, ambition and loyalty. We offer competitive wages and benefits. Performance driven, customer focused individuals should forward their resume in person to:
Jim Strickland, Manager
Tirecraft Commercial (Ont.) Inc.
1400 Phillip Murray Avenue
Oshawa, Ontario L1J 7E8

Y "SUMMER'S COMING"
 Looking for Full Time Employment?
 Join Us for a FREE BBQ!
AGES 16-24
 Come and find out about job opportunities
YMCA Durham Employment Services
Wednesday, February 27, 2002
12:00 p.m. to 2:00 p.m.
1550 Kingston Road, Pickering
(Corner of Kingston Road and Valleyfarm Road)
905-427-7670

510 General Help **510** General Help

A major U.S. based company is seeking qualified applicants for a call centre in the Town of Ajax. Staffing will commence for these full time positions in the next two to six months.
CUSTOMER SERVICE ASSOCIATES
 As a key member of a premier call centre in Ajax, you will be responsible for receiving inbound calls, responding to customer correspondence and email, and providing a high level of customer service. As a highly motivated individual with a strong customer focus, you will ideally possess a positive, professional attitude. Call centre or retail experience is an asset. An extensive training program is offered by the employer. Starting salary \$8.00 - \$10.00 per hour plus an outstanding benefits package.
 Join a team of leading-edge professionals as they launch this exciting new venture!
Fax your confidential resume to:
(905) 683-7629

WE ARE SEEKING GOAL ORIENTED INDIVIDUALS TO SELL FOR OUR COMPANY
 We are Canada's largest Lawncare Company & we are expanding. Our company has a 30 year proven track record & an unique atmosphere that rewards achievers both intellectually & financially.
 • Guaranteed \$10 per hour plus commission
 • Average earnings of \$15-\$20 per hour with commission
 • Additional sales incentives add up to \$1,000 per season
 • Afternoon & evening shifts available total 34 hours per week
 • Great supplemental income opportunity
 • Automated dialing system
 • Good verbal communication skills essential
AJAX LOCATION: 62 Harwood S. (Harwood & 401)
For interview please call: 416-269-8333
Weed Man

PART-TIME EVENINGS
 Part-time positions available, \$15./per hr. Car required. Ideal for Homemakers or as a Second income, Call from 9am-4pm at 905-686-9842 ext. 302 After 4pm call 905-686-2445 ext. 302

THE TORONTO STAR CIRCULATION SALES DEPT
 •Our Sales Department is expanding. A Career opportunity is now available for Independent Crew Managers in the Durham Region.
 •The successful candidate should be able to work with and motivate youths.
 • Full training provided
 • Must have good driving record.
 • A van is required.
 • \$700/week & up commission is attainable.
 For Personal Interview Please Call **Dean Bowler 905-261-0145**
ALSO
 Positions Available for **STUDENTS** to do door-to-door sales.
THE TORONTO STAR

Y "SUMMER'S COMING"
 Looking for Full Time Employment?
 Join Us for a FREE BBQ!
AGES 16-24
 Come and find out about job opportunities
YMCA Durham Employment Services
Wednesday, February 27, 2002
12:00 p.m. to 2:00 p.m.
1550 Kingston Road, Pickering
(Corner of Kingston Road and Valleyfarm Road)
905-427-7670

510 General Help **510** General Help

HARD WORKING RELIABLE
 House cleaners Needed 4-5 days a week. 5-6 hours per day. (Drivers license an asset) Transportation provided in Ajax and Pickering. Call 905-428-9765.
INTERNATIONAL MARKETING
 company expanding into Durham. 1-800-572-5360. www.acareerisonline.com
J.O.B.S. Need immediate workers. Weekly pay. No experience necessary. F/T, 18+. Call Marcus 905-435-0730
JOCUS EDUCATIONAL TOYS, needs representatives in Durham Region. Great products, 65% under \$15, home parties, fund raisers & catalog sales. Canadian company. 1-800-361-4587 ext. 9369
LANDSCAPE DESIGNER to work freelance, approx. 40-50 designs a year. Fax resume to Greenbank Garden Centre 905-985-7096.
LARGE Architectural Millwork company seeks "NIGHT SHIFT GENERAL LABOUR" in Durham Region area. Please fax resume to: 905-433-1463.
LOOKING FOR PEOPLE with leadership skills who enjoy interaction with others. Financially rewarding. Fun and interesting. Must have own transportation. Call 905-430-3815
LUBE TECHNICIAN PLUS ASSISTANT MANAGER - full + part time, hourly wage plus bonus. Experience needed. Valid drivers license. Apply at Penzoil, 195 Westney Rd. S. of 401 Ajax. (905) 427-6796
MA-LE ENTERPRISES - 3 people to be hired by Mar. 15th/02. No selling required. Reliable vehicle necessary. Excellent opportunity for mothers at home while kids are at school. For interview call 905-983-5412.
MORNINGSIDE/401 area - We will train. \$9/hr steady day shift in our shop. Some heavy lifting. Reply only 12:00pm-4:00pm Monday, February 25. 416-283-2350.
NO LAYOFFS!!!! First 100 people interviewed. Marketing, public relations, customer service to management. Call Nicole 905-435-3478
OSHAWA BASED company requires "AZ" drivers to run U.S. Favourable pay package available. For details please call dispatch at 905-725-5090
PERFORMANCE ORTHOTICS has an opening for an entry level position in our manufacturing plant in Pickering. Must have good communication skills. Will train. Fax resume to 905-420-0877.
PLENTY OF WORK!! Call George 905-435-8131
REED'S FLORIST is hiring mature supervisor for Pickering Town Centre. Fax to (905) 683-0481
SIX FIGURE INCOME plus for hardworking people. Energy sales. Call John 1-800-293-0067.

515 Skilled & Technical Help
515 Skilled & Technical Help
Experienced CLASS A TECHNICIANS required. Apply in person: **MENZIES CHRYSLER** 1602 Champlain Ave. Whitby ATT: Clarke Menzies
Industrial Maintenance Electrician
 Your Electrician Certificate combined with experience in PLC, control wiring, troubleshooting and understanding the Code are essential. Salary negotiable. FAX resume to (905)435-0598 or e-mail humanresources@ancon-ind.com

510 Computer & IT
510 Computer & IT
SECRETARY/RECEPTIONIST required by busy hi-tech company. Knowledge of Excel, MYOB and Microsoft Word required. Must also have excellent customer service skills and possess an attitude that "The Customer Comes First". Please email resume to: **CARDAC@KEYSCAN.CA**

510 General Help
510 General Help
REQUIRED IMMEDIATELY - Estimator for Earthwork company located in Durham. Must have experience in earthwork takeoffs, site stripping and balancing, backfill, etc. Ability for project management and layout a definite asset. Excellent salary, benefits and vehicle are offered as part of this package. Fax resume to: (905) 839-9476
Shipper/Receiver/ Shop Hand. Forklift experience a must. Duties to start include shipping and receiving and assisting Service Staff when required. Computer and welding experience an asset. Must have valid drivers license. Please reply with resume and references to Machinex Recycling Technologies, 963 Brock Rd., South #10, Pickering, ON. L1W 3A4 or fax (905) 420-0319.
STRONG VOICES NEEDED! Telephone sales re: police retirees. Work from our office Monday - Friday, 10 a.m. - 4 p.m. or 4:45 to 8 p.m. Salary plus bonus plus commission. Phone (905) 579-6222.
SUPERINTENDENT COUPLE, required for luxury highrise condominium, located in Durham Region. Experienced applicants only, should forward their resume including salary expectations to Guardian Property Management at 339 Westney Rd. S. Suite 206, Ajax, L1S 7J6 Attention: Ian Slater. References required.
TELEMARKETERS: Certified Htg & A/C Service Experts seek experienced individuals to work in our Service Call Centre and perform general office duties. Must possess superior people and telephone skills. Competitive wages, benefits plus commission. Call (905)683-0387 or fax (905)683-3377.

514 Sales Spa
ELEGANCE SALON SPA seeking Estheticians Hairstylists, full & part-time. Forward resume to 123 St. Whitby, Attention: Beverley
515 Skills Technical H
A RAPIDLY GROWING FIRM in the Durham Region is seeking a full-time CAD Designer/Junior Application signer. A C.E.T. or C.Tech (or equivalent) in a CAD application is a must. A strong background in AutoCAD is required. Competitive wages and benefits. Please email a detailed resume to: xltmanufacturing@sympatico.ca
AZ DRIVER REQUIRED. Drivers Wanted for US, Eastern and southern states. pick up, delivery and mileage. US Medical and disability. cellent equipment available. Serious drivers with records only please. Fax resume to: manville Location. Fax resume (905)697-1807 or (905)697-1403
WANTED TELEPHONE SALES REP. to work from home. Excellent sales & communication skills. \$15/hr. + bonuses. Call **905-427-8822**
THE TAP & TANKARD Hiring Kitchen Manager and Line Cook. Experienced applicants need only apply. 224 Brock St. S., Whitby. Fax 905-666-0306 Attn: Jamie/Brett

511 Retail Opportunities **511 Retail Opportunities**

ATTENTION: PET LOVERS
 Unleash your potential with PET VALU, specialty retailer of quality pet products with over 340 locations internationally! If you're a pet lover or would just love to have a great job in retail, PET VALU has a tremendous opportunity available at its Abbey Lane Shopping Centre store, located at 91 Rylander Blvd., Unit 15A, Scarborough.
STORE MANAGER
 This position offers benefits, paid statutory holidays, vacation, personal days, as well as on-the-job management training.
Candidates must:
 • be capable of moderately heavy lifting
 • have previous cash/customer service experience
To apply please fax resumes to 1-905-946-1866 or email to hr@petvalu.com
 Please indicate your availability.
PET VALU
 Your Neighbourhood Store With Superstore Prices

515 Skilled & Technical Help
515 Skilled & Technical Help
Experienced CLASS A TECHNICIANS required. Apply in person: **MENZIES CHRYSLER** 1602 Champlain Ave. Whitby ATT: Clarke Menzies
Industrial Maintenance Electrician
 Your Electrician Certificate combined with experience in PLC, control wiring, troubleshooting and understanding the Code are essential. Salary negotiable. FAX resume to (905)435-0598 or e-mail humanresources@ancon-ind.com

510 Computer & IT
510 Computer & IT
SECRETARY/RECEPTIONIST required by busy hi-tech company. Knowledge of Excel, MYOB and Microsoft Word required. Must also have excellent customer service skills and possess an attitude that "The Customer Comes First". Please email resume to: **CARDAC@KEYSCAN.CA**

510 General Help
510 General Help
REQUIRED IMMEDIATELY - Estimator for Earthwork company located in Durham. Must have experience in earthwork takeoffs, site stripping and balancing, backfill, etc. Ability for project management and layout a definite asset. Excellent salary, benefits and vehicle are offered as part of this package. Fax resume to: (905) 839-9476
Shipper/Receiver/ Shop Hand. Forklift experience a must. Duties to start include shipping and receiving and assisting Service Staff when required. Computer and welding experience an asset. Must have valid drivers license. Please reply with resume and references to Machinex Recycling Technologies, 963 Brock Rd., South #10, Pickering, ON. L1W 3A4 or fax (905) 420-0319.
STRONG VOICES NEEDED! Telephone sales re: police retirees. Work from our office Monday - Friday, 10 a.m. - 4 p.m. or 4:45 to 8 p.m. Salary plus bonus plus commission. Phone (905) 579-6222.
SUPERINTENDENT COUPLE, required for luxury highrise condominium, located in Durham Region. Experienced applicants only, should forward their resume including salary expectations to Guardian Property Management at 339 Westney Rd. S. Suite 206, Ajax, L1S 7J6 Attention: Ian Slater. References required.
TELEMARKETERS: Certified Htg & A/C Service Experts seek experienced individuals to work in our Service Call Centre and perform general office duties. Must possess superior people and telephone skills. Competitive wages, benefits plus commission. Call (905)683-0387 or fax (905)683-3377.

514 Sales Spa
ELEGANCE SALON SPA seeking Estheticians Hairstylists, full & part-time. Forward resume to 123 St. Whitby, Attention: Beverley
515 Skills Technical H
A RAPIDLY GROWING FIRM in the Durham Region is seeking a full-time CAD Designer/Junior Application signer. A C.E.T. or C.Tech (or equivalent) in a CAD application is a must. A strong background in AutoCAD is required. Competitive wages and benefits. Please email a detailed resume to: xltmanufacturing@sympatico.ca
AZ DRIVER REQUIRED. Drivers Wanted for US, Eastern and southern states. pick up, delivery and mileage. US Medical and disability. cellent equipment available. Serious drivers with records only please. Fax resume to: manville Location. Fax resume (905)697-1807 or (905)697-1403
WANTED TELEPHONE SALES REP. to work from home. Excellent sales & communication skills. \$15/hr. + bonuses. Call **905-427-8822**
THE TAP & TANKARD Hiring Kitchen Manager and Line Cook. Experienced applicants need only apply. 224 Brock St. S., Whitby. Fax 905-666-0306 Attn: Jamie/Brett

530 Sales Help & Agents

ALLSTATE
We're growing in Ajax and Pickering!
We are looking for successful **SALES PERFORMERS** to help us achieve our growth plans.
WE OFFER:
• Unlimited income potential
• Employee benefits
• An opportunity to run your own office
RIBO, OTL, & LIFE Lic's Welcome
Send resume to:
Bernie Korte
650 Kingston Rd.
Pickering Ont. L1V 1A6
bkorte@allstate.ca
or fax: 905-420-5730

515 Skilled & Technical Help

LARGE Architectural Millwork company seeks "CABINET MAKER" in Durham Region area. Fully experienced please. Please fax resume to: 905-433-1463.

PIONEER POOLS MARKHAM requires Vinyl Pool Installer. Concrete finishing expertise essential. Own transportation, excellent wages, lots of work, five day week. Fax resume to 905-831-4156.

SECOND & THIRD YEAR Apprentices Wire EDM operator, CNC operator/programmer, with tool & dye experience only. Junior Tool Designer with CADkey experience. Fax resume to (905)642-6168

525 Office Help

ADMIN. ASSISTANT Required Homebuilder requires pleasant, professional and service oriented person to join sales team. Must have excellent computer skills, Word, Excel, Mail Merge. \$12/h. Whitby location, 4 days/wk incl. Sat & Sun. Starts immediately. Please fax resume to 416-628-5581.

BILINGUAL OFFICE Administrator required for sign company in Ajax. Must be neat, professional, computer literate with typing and telephone skills. Fax resumes attn. Phil 905-428-1790

PART TIME OFFICE help. Computer and typing skills required. Fax resume to: 905-426-6192.

530 Sales Help & Agents

AJAX - DIGITAL PRINT and copy shop looking for full time experienced sales person. Please fax your resume to (905) 619-1296.

EARN \$40K+ - Sales Rep. Busy Ajax weight loss centre needs ambitious, self-motivated person. Must be fit & healthy. Experience in weight loss an asset. RaeAnne 905-619-2639 ext.241

NEW HOMES SALES
Excellent opportunity for exp. new home Sales Person.
Fax resume to 416-650-1232

535 Hospital/Medical/Dental

BUSY COBOURG progressive Dental Practice committed to dental excellence is seeking an ambitious, energetic, detail-oriented **CERTIFIED DENTAL ASSISTANT** to join our team. F/T availability due to maternity leave, willing to train. Serious applicants only. Fax resume to: 905-372-9439.

DENTAL RECEPTIONIST required, full-time, some evenings and Saturdays. 2 or more years computer experience necessary. Mail resume to: Dr. Stephen Murray, 1300 King St. E. Oshawa, L1H 8J4 or fax to: (905)436-3480.

DENTAL RECEPTIONISTS/Office, assistants Level I & II, for Whitby/Oshawa area. Seeking independent, motivated individuals. Pay up to \$25/hr. Send resumes to FRIENDLY STAFF File #767, c/o Oshawa This Week, PO Box 481, 865 Farewell St., Oshawa L1H 7L5

HYGIENIST needed to cover maternity leave at Ajax office starting April 22nd. Hrs: Mon, 1-8; Wed, 8-7; Thurs, 8-5; Sat, 9-5 (once a month). Please send resume to: File #783, Oshawa This Week, 865 Farewell St. Oshawa Ont. L1H 7L5.

MEDICAL SECRETARY/Office Manager required for specialist's office - Oshawa. Full time. Reception, OHIP billing, dicta typing preferred. Reply to File #785 Oshawa This Week, P.O. Box 481, Oshawa, Ontario, L1H 7L5.

535 Hospital/Medical/Dental

Renovations at major Toronto community hospital create many new opportunities.

REGISTERED NURSES



Humber River Regional Hospital is one of Canada's largest regional community hospitals, offering a full range of medical services to the people of northwest Toronto. We have been designated by the Ontario Ministry of Health and Long-Term Care, as a Regional MRI Centre and a Regional Dialysis Centre, with Canada's first home nocturnal dialysis program. We are a Regional Paediatric Centre and a member of the Child Health Network of

Greater Toronto. World-class programs like these, and some of the very best employees in the health-care system, make our organization The Hospital of choice ... committed to patient needs.

"Our future plans are exciting. It's a great time to join our team."
Reuben Devlin, President and CEO

At Humber River Regional Hospital, we have great plans for the future! We have received a \$100-million investment from the Ontario Ministry of Health and Long-Term Care to upgrade and expand facilities and programs. As a result, we have a number of exciting opportunities available for RNs to join our team in a variety of areas.

Committed to the personal and professional development of our employees, we have an outstanding staff education program, including a

tuition reimbursement plan for appropriate university and college courses. We offer a thorough, paid orientation program for new staff - we'll spend up to 6 weeks helping you grow into your new career at our hospital.

Our commitment to providing patients and the community with the highest levels of service remains central to all that we do. If you feel the same way, please forward your resume to: **Humber River Regional Hospital, Human Resources Department, Finch Avenue Site, 2111 Finch Avenue West, Toronto, Ontario, M3N 1N1. Fax: 416-747-3758. Call toll-free: 1-866-397-2483. E-mail: recruitment@hrrh.on.ca**



We thank all applicants for their interest, but advise that only those selected for an interview will be contacted. We are an equal opportunity employer.

Sunnycrest Nursing Home
"People Caring For People"
P/T- RN's/RPN's - ALL SHIFTS
Experienced in LTC
Computer literacy an asset.
Mail/fax resume to:
Director of Resident Care
1635 Dundas St. E.
Whitby, ON. L1N 2K9
Fax: 905-576-4712

150 Office & Business Space

NEWLY RENOVATED-AJAX
Best Suited for:
♦ Professional Offices
♦ Private Educational Centre
♦ Medical/Dental Clinic
Air Conditioned ♦ Kitchenette
Ample Parking ♦ Bus Stops at Door
Located in small plaza adjacent to parkette & close to Lake Ontario
2 Outlets (may be joined)
829 and 1,141 square feet
925/927 Finley Ave., Ajax
(Immediate Occupancy)
May Be Viewed From Exterior
Info On Windows
For Inspection - **Joseph 905-579-7252**

145 Industrial/Commercial Space

HEATED SHOP FOR RENT w/security system, near 401, 2-10' insulated overhead doors, with loft, 12'x52' indoor cold storage & 30'x60' fenced-in compound, available immediately. Please call 905-987-1445

150 Office & Business Space

FREE - ONE MONTH. Desirable Rossland/Simcoe Oshawa location. 400 sq. ft. furnished office space. \$350/month plus GST. Won't last! Call Steve 905-576-6999.

OFFICE/PROFESSIONAL space. 400 - 2400 sq. ft. Prime downtown Whitby location. Ground floor, private entrance and parking. Call Joanna @ 905-579-6245.

160 Business Opportunities

\$\$\$ GOVERNMENT - Funds Grants and loans information to start and expand your business or farm. 1-800-505-8866

ARE YOU SICK OF THE DAILY Commute!! Take a look at our business opportunity. Visit our website www.workathome-earn-money.com or call 416-812-6595.

EXCELLENT OPPORTUNITY Durham bakery for sale. Fantastic potential. Established clientele. Turnkey. For info call Barry McLean at 1-800-461-6499

535 Hospital/Medical/Dental

EXPERIENCED cleaning lady available, quality service at excellent rates. Call Julie at (416) 879-7033. (Cell)

555 Domestic Help Available

C'MARIA'S HOUSE CLEANING. Affordable prices for cleaning houses and offices. Free estimates. Call Maria 905-436-8645 or email kcza@sympatico.ca

150 Office & Business Space

EXPERIENCED cleaning lady available, quality service at excellent rates. Call Julie at (416) 879-7033. (Cell)

100 Houses For Sale

WHITBY'S #1 LOCATION the best in education facilities, 4-bedroom 2 story complete with all upgrades, professionally landscaped & decorated, full finished basement with office, 3600 sq.ft \$319,000. (905)576-9933.

105 Townhouses For Sale

FABULOUS END UNIT \$182,900. in very small upscale complex. Steps from Pickering Town Centre, all amenities, 401 and bus/Go! C/Air, high-efficiency gas furnace, fresh "Ralph Lauren" paint, 5 appliances, parking for 2 vehicles (plus garage). Very quiet, private patio! 1635 Pickering Parkway #8. Please call for apt. 905-428-0580.

130 Houses Wanted

SOLD OUT! Homes wanted for clients waiting. Get top prices, low interest rates. FREE Evaluation. Ron Barsi, Assoc. Broker, Sutton Group Status Realty Inc. (905)436-0990

140 Investment/Bus. Property

21 SUITES Apartment building, all brick, N.Oshawa on huge 214ft. lot. Gas heat, separate meters, many upgrades. Exclusive R. Barsi, Assoc. Broker, (905)436-0990 Sutton Status Realty.

145 Indust./Comm. Space

2,000 SQ. FT. retail/ industrial Space for rent, office front, 12 ft. x 14 ft. drive-in overhead door, 25 ft. ceiling height, close to 401 (2 exits), Wentworth St. E., area. Call days (905) 433-4161, evenings (905) 579-5909. No Auto Body or Auto Repair.

170 Apartments & Flats For Rent

2-BEDROOM available anytime. Located 309 Cordova Rd., Oshawa. No pets. Please call 905-579-2387, after 5pm

2-BDRM BASEMENT APT. near OC, separate entrance, quiet neighbourhood, 4 appliances, utilities & cable included. \$800/month. First & last, non-smoker preferred, no pets. Call Dominic (905)433-4107 between 10am-6pm, after 6pm 905-922-7783

3-BDRM MAIN FLOOR. large backyard, shared washer/dryer, 2 car parking, Harwood/Bayly, AJAX. \$1325/month inclusive. No smoking/pets. Avail. Mar. 1. 1st/last. (905)420-1037, leave message.

2 BEDROOM BASEMENT APT. March 1st. Large, updated, bright. Separate entrance. No smoking/pets. Utilities included. \$850/month. Call Alasdair McLean 905-427-3948.

AAA1 - SMALLER one bedroom apartment near Oshawa Centre. 1st/last required. April 1st. \$495 per month inclusive. Please call (905) 666-8533.

WHITBY GARDENS - 900 Dundas St. E. One and two bedroom apartments available in clean, quiet building. Utilities included. Laundry facilities and parking available. Call (905)430-5420.

145 Industrial/Commercial Space

EXCELLENT ASSOCIATE Partnership opportunity with an established private practice - Social Worker or Family Counselling or Psychologist. Prime Whitby location. Phone 905-665-9652.

161 Franchises

THE GOURMET CUP franchise opportunity. Northumberland Mall. Exciting new coffee retailer coming to town. Attractive store design. 26+ year national chain. Full head office training and support. Info: Call weekdays 8 am - 4 pm (pst) 1-800-663-4213.

170 Apts. & Flats For Rent

1 BIG NEW basement apartment, Whites/Finch, all bills included, \$700/month. No pets, no smoking. First/last. Call Mary (905)420-5975

2 BEDROOM APT. well maintained adult building, on side street, near Ritson/Bloor St. Oshawa. First/last, references required. \$800/month. Avail. Mar. 1st. Call 905-426-5713

2 BEDROOM spacious clean apartment in 4-plex, centrally located (John/Centre) laundry facilities, first/last \$725 + hydro. Avail. Apr. 1. Call days 905-728-5540 or evenings 905-666-9549

170 Apartments & Flats For Rent

BRAND NEW 2 bedroom apartment, bright, 1 parking. No smoking, no pets. Available immediately. Brock/Finch, near plazas, schools, transport. \$950. 905) 686-3877 or (416) 456-7245

BRIGHT NEW one bedroom basement apartment, 1,100 sq. ft. Wilson and Olive, available immediately. \$700 all inclusive. Laundry, perfect for single professional. (416) 809-4362

BRIGHT SPACIOUS freshly painted 2 bedroom apt. Huge living + dining room, private backyard, air conditioned. Prefer mature working single/couple. No pets, first/last \$1,000/mo. inclusive. Available April 1st. 905-666-1817

CENTRAL OSHAWA. 2-bedroom \$800 March 1st. 3-bedroom \$925, March 1st. 1-bedroom March 1st \$750. April 1st - 2 bedroom \$850; 3 bedroom \$950. In well-maintained building, close to all amenities. Please call (905)723-0977 9a.m.-6p.m.

COURTIE TWO bright 1-bedroom apartments available. Includes c/a, parking, all utilities. Asking \$575 & \$685 per month. Absolutely no dogs. Call Cindy (905)725-2246

EXECUTIVE large 2 bedroom in quiet adult lifestyle building in Whitby. New carpet, onsite storage, onsite laundry, \$925+ per month. 905-668-7758.

145 Industrial/Commercial Space

FULLY FURNISHED 2 bedroom basement apartment, separate entrance, all inclusive, no smokers or pets, first/last required. Avail. immediately \$800. Call after 2pm 905-428-9441

LIVERPOOL/BAYLY 2 bedroom basement apt. Separate side entrance, \$800/month all inclusive, no pets, avail. immediately. 905-831-3861

NEW - SPACIOUS basement apt. Walkout, one master bedroom, laundry, living/dining-room, bathroom. Available immediately, \$750/first/last includes utilities. One-car parking. Non-smoker, no pets. Brock/Hwy 2 Pickering. Call 905-426-7800 or 905-426-6656

ONE & TWO BEDROOM apts. for rent. One bedroom March 1st; Two bedroom April 1st and May 1st. Conveniently located in Uxbridge in adult occupied building. Apts. to view call 905-852-2534.

ONE & TWO BEDROOM apartments, in most beautiful adult lifestyle building. Avail. immediately. Stevenson & Rossland, Oshawa. Call (905)579-3700 or (905)723-1009

ONE BEDROOM CONDO for rent in Pickering. All appliances. 1 1/2 baths, cable, parking spot, air, available April 1st, \$1150/month inclusive. Call Rose 905-839-0640

170 Apartments & Flats For Rent

RENT-WORRY FREE
1, 2 & 3 Bed. Apts.
Well maintained, modern Appliances. All Util. included.
On site super, maintenance & security.
Rental Office: Mon - Fri. 12 noon - 8pm
Sat & Sun 1pm- 5pm

VALIANT PROPERTY MANAGEMENT
905-579-1626
www.gscrentals.com
e-mail: valiant@speedline.ca

2 NEWLY BUILT 2-BDRM APTS located downtown Oshawa. \$790 + utilities per month. Call Anna 905-728-2258

ONE BEDROOM APT. located at 782 Ritson Rd. S., \$500 & heat/hydro, 1st & last, Avail. now, no smoking, no pets, references. Call 905-263-8449, 905-579-9008, 905-723-3345.

OSHAWA - 2 BEDROOM apt. washer/dryer each floor. Very quiet, exclusive, adult preferred building. No pets. 905-579-9016

OSHAWA 1-BEDROOM basement apartment, c/a, parking, laundry facilities, non-smoker, no pets. \$750/month inclusive first/last required. Available March 1st. (905)728-8122.

OSHAWA APTS. - Bachelor, 1 and 2 bedroom, newer buildings. Includes utilities, parking, laundry on-site. No dogs. Building #1 905-432-8914, Building #2, #3, #4 905-571-0425 or for all 1-888-558-2622

OSHAWA BASEMENT Bachelor apartment, newly renovated, Adelaide/Gibbons, parking, laundry, air conditioned, single female preferred. Available March 15th. \$650/month. First/last. Laura (905)404-1613, Margaret (905)579-8829, afternoons, evenings.

SOUTH SIMCOE - 2 bedroom apt. with deck. Large & spacious living and dining room. Available March 1st. No dogs. 1st & last. Call 905-666-4670.

PICKERING - Liverpool Rd, large 2 bedroom basement. Full kitchen and bathroom. Own laundry and entrance. No pets. Utilities included. \$900. Call 416-494-3765.

PICKERING VILLAGE. 2-bedroom basement apartment in quiet home, no smoking or pets. Available immediately. Call (905)683-6743

170 Apartments & Flats For Rent

3 BEDROOM BUNGA near Philip Murray. Two+ baths, finished basement, recently renovated, private, no smoking/pets. \$1175/mo. utilities. Avail. April 1st. last, references. 905-4873

3 BEDROOM. well-kept & utive home, Bowman Near schools, downtown, access. Gas heat, 2-gas places, fridge/stove, washer/dryer, single garage. March \$1400 +utilities. Apply in ing: 110 Mill St.S., Newcas On L1B 1C5

3-BEDROOM SEMI. c/a, large yard, 4 appliances, parking, close to Oshawa Centre, asking \$1100. 1st. last required. Available March 1st. Call (905)666-1349 5pm.

AN UNBEATABLE DEAL! \$500. down, own your home starting at \$69,900. 24 hrs free recorded mes. 905-728-1069 ext 277. Call well Banker RMR Real Es. Aurelia Rasanu.

A-A-A - MANY HOUSES for rent in Pickering, Whitby, Oshawa, Bowmanville surrounding areas. Rent \$1,100 to \$5,000 per month plus utilities. BRAND 3200 sq.ft. all brick home, bedrooms, appliances, h/w floors, double car garage, \$2900 plus utilities. Available March 1st. Call Roy Bolen, Sutton Group S at 905-436-0990 (MUST for Jan Van Driel for info scheduling).

CHARMING 1.5 STORY bedroom house on street. Nice yard, laundry parking available. smoker preferred. \$1075/month plus utilities. Call Angela 905-509-3043

COURTIE 3-bedroom, rage, walkout to covered +fenced yard, park +amen nearby. \$1,250 +util credit check, 1st/last. A Mar./Apr. 1. No Pets. 905-4689

OSHAWA - 3 bedroom floor bungalow, newly renovated, 5 appliances, 1 parking, 1st/last, no pets, \$1,275 inclusive. Telephone (416) 6525 leave message

PICKERING - Liverpool Rd, large 2 bedroom basement. Full kitchen and bathroom. Own laundry and entrance. No pets. Utilities included. \$900. Call 416-494-3765.

PICKERING VILLAGE. 2-bedroom basement apartment in quiet home, no smoking or pets. Available immediately. Call (905)683-6743

WHITBY - one bedroom \$730. Available April 1st. Office hours 9-5pm Monday-Friday & 6pm-8pm Monday - Thursday (905)665-7543.

PICKERING - 3-bdrm detached, double appliances, quiet court partially finished bsm double garage. Avail. March 1st. \$1350 plus Lemon Tree Property (905) 839-9227.

170 Apartments & Flats For Rent

SPACIOUS well-maintained & 3 bedroom apts. Avail. 900 and 888 Glen St. S. with walk-in closets, provided. Close to shopping centre, GO Sta. Utilities included. (905)728-4993.

WALK OUT bsmt. apt. for rent at Bayly/Pickering Bch. \$800 monthly (+ 1st Last). incl Laundry uti. Non smoker preferred. parking limited. 905-427-6217

WHITBY 1-BEDROOM area, upper floor, separate entrance, utilities, a/c, sat. included. No smokers, no pets. \$700/month. (905)434-1066

WHITBY 3-BEDROOM floor of house, 4 pc. bath, ingroom, diningroom, kitchen, shared laundry \$1200 mo. plus 2/3 utilities, pets, no-smoking, first, references required. Available March 1st. Call for 905-655-9624.

WHITBY one bedroom basement apt., available March separate entrance, no pets smoking \$650. 905-626-905-666-2745.

WHY rent when you can own your home for less? your own home? Call Dave Lock Sales Rep. Re Summit Realty (1991) (905) 668-3800 or (905) 3211.

185 Houses For Sale

Sick of RENTING?
1st Time Buyer? Professional Rental...! Honest Answers...! Professional Advice...! To "Own" Your Next Home...! Direct
1-800-840-62
905-571-6275
RE/MAX Realty R.E.
Mark Stapley Sales

*** A RENT ALTERNATIVE** If you are currently paying between \$900-\$1400 a month I can help you own. My Detering Re/Max Rouge 905-668-1800

3 BEDROOM BUNGA near Philip Murray. Two+ baths, finished basement, recently renovated, private, no smoking/pets. \$1175/mo. utilities. Avail. April 1st. last, references. 905-4873

3 BEDROOM. well-kept & utive home, Bowman Near schools, downtown, access. Gas heat, 2-gas places, fridge/stove, washer/dryer, single garage. March \$1400 +utilities. Apply in ing: 110 Mill St.S., Newcas On L1B 1C5

3-BEDROOM SEMI. c/a, large yard, 4 appliances, parking, close to Oshawa Centre, asking \$1100. 1st. last required. Available March 1st. Call (905)666-1349 5pm.

AN UNBEATABLE DEAL! \$500. down, own your home starting at \$69,900. 24 hrs free recorded mes. 905-728-1069 ext 277. Call well Banker RMR Real Es. Aurelia Rasanu.

A-A-A - MANY HOUSES for rent in Pickering, Whitby, Oshawa, Bowmanville surrounding areas. Rent \$1,100 to \$5,000 per month plus utilities. BRAND 3200 sq.ft. all brick home, bedrooms, appliances, h/w floors, double car garage, \$2900 plus utilities. Available March 1st. Call Roy Bolen, Sutton Group S at 905-436-0990 (MUST for Jan Van Driel for info scheduling).

CHARMING 1.5 STORY bedroom house on street. Nice yard, laundry parking available. smoker preferred. \$1075/month plus utilities. Call Angela 905-509-3043

COURTIE 3-bedroom, rage, walkout to covered +fenced yard, park +amen nearby. \$1,250 +util credit check, 1st/last. A Mar./Apr. 1. No Pets. 905-4689

OSHAWA - 3 bedroom floor bungalow, newly renovated, 5 appliances, 1 parking, 1st/last, no pets, \$1,275 inclusive. Telephone (416) 6525 leave message

PICKERING - Liverpool Rd, large 2 bedroom basement. Full kitchen and bathroom. Own laundry and entrance. No pets. Utilities included. \$900. Call 416-494-3765.

PICKERING VILLAGE. 2-bedroom basement apartment in quiet home, no smoking or pets. Available immediately. Call (905)683-6743

WHITBY - one bedroom \$730. Available April 1st. Office hours 9-5pm Monday-Friday & 6pm-8pm Monday - Thursday (905)665-7543.

185 Houses For Rent **185 Houses For Rent**

OWN A HOME
 * NO MONEY DOWN * LEASE TO OWN *
ARTEN REAL ESTATE CENTRE INC. BROKER
some restrictions apply
Central, North East
416-504-7259
 www.artengroup.com

WHITBY 3 BEDROOM bungalow, quiet neighborhood, near amenities, recently renovated, central air, no pets/smokers, references, credit check. \$1,200 plus damage deposit/ utilities. March 1st. (905) 665-8294

AJAX, SMALL 2-bedroom wartime house, 5 appliances, all utilities and cable included. Harwood/401, available immediately. Call after 6pm (905)706-5200.

190 Townhouses For Rent

PRINGLE CREEK CO-OP 95 Crawford St., Unit-85 Whitby, is accepting applications for next orientation for March, 3bdrm. townhouses. \$849 + \$870 plus. Applications available at Community Centre Unit 85, 10am-4pm. Mon-Thurs. (On Friday, Sat & Sun pickup points are posted on Community Centre's door between 10am-7pm.) SORRY, NO SUBSIDY AVAILABLE.

3-STOREY LUXURY town-home Brock Rd/Kingston Pickering, 3-spacious bedrooms, 3 bathrooms, living/diningroom, kitchen, basement, walkout to underground parking. Minutes from PTC, GO train, grocery store. \$2100/month. (905)509-1731

191 Housing Wanted

WANTED TO RENT: Country home, any size in north Durham, North York or Scugog for responsible, handy young couple. Call Jamie (905)686-1889.

192 Rooms For Rent & Wanted

\$400/MONTH, first/last. Mature working person preferred. References. No parking. Cable, laundry, phone included. Share kitchen, no pets/no smoking. References. Pickering Beach Rd/Hwy. 2 Ajax. 905-619-0999

AJAX, WESTNEY/ROSSLAND 1-room, clean home, quiet street, a/c, cable, use of kitchen/laundry, parking. No smoking/pets. Suits steadily employed person. First/last. \$550/month, available immediately. 905-426-2812

WEST PICKERING, furnished room in clean quiet home, prefer employed non-smoker. Share separate kitchen, bathrooms. Parking, references, first/last. Call (905)509-2459

FURNISHED room for rent, private bath, private entrance, on bus route. \$450 per mo. 1st/last. Available immediately. Harwood/Hwy 2. Telephone (905) 427-9576

LIVERPOOL/BAILEY Unfurnished bed-sitting room with private bath in quiet home. Mature, employed person preferred. Non-smoker. Use of kitchen/laundry/patio/parking. \$115/week including cable, first/last. References. 905-837-0556 leave message.

NORTH OSHAWA, near Durham College, fully furnished basement rooms with satellite dish, share kitchen & bathroom. \$450/month. Available immediately. No smoking, no pets. (905)743-9448

194 Shared Accommodation

AJAX - SHARE LARGE newer home. Parking, laundry, own phone, cable, storage. Own bath. Close to all amenities. Phone (905)683-9213

HARMONY/401 OSHAWA -3 bedroom furnished home to share with a senior lady. Non-smoking employed woman preferred. \$100/week. Phone 905-723-6243.

PICKERING - large house to share. Sheppard and Whites area, parking, laundry, serious replies only call Jeff 905-831-8739 leave message

PICKERING - Brock/Hwy. 2 - large bedroom with private bathroom, share kitchen, laundry, backyard, parking, working female preferred \$550/month, first/last/references. No smoking/pets. April 1st. 416-885-4485.

SHARED HOUSE, on Simcoe south of Rossland, parking, gas fireplace, clean, quiet on bus route, no smoking, no pets. Working persons preferred, avail. immediately 905-432-1947.

HOUSE TO SHARE Central Oshawa. Non-smoker only, suitable for a mature working person. No pets. Parking. \$475 inclusive, avail. March 1st or sooner. (905)720-1533.

310 Articles for Sale

CARPETS SALE & HARDWOOD FLOORING: carpet 3 rooms from \$339. (30 sq. yd.) Includes: carpet, premium pad and installation. Free estimates, carpet repairs. Serving Durham and surrounding area. Credit Cards Accepted Call Sam 905-686-1772.

CARPETS! CARPETS! CARPETS! 3 rooms carpeted with pad and installation \$299 (32 yds.). SPECIAL BUY - 24oz Berber, 10 colours, \$7.50/yd. 32oz Berber, 12 colours, \$8.50/yd. 45oz Nylon Saxony, 30 colours, \$13.50/yd. NO HIDDEN COSTS. Free shoot at Home Service. Guaranteed Best Prices. SAILLIAN CARPETS, 905-373-2260.

SOFT TUB, 4 man, mint shape, \$1800. COMPUTER - PentiumII 266-64MB Ram, 4 GBHD, 56K modem, CD Rom, floppy, keyboard, speakers/mouse, SVGA monitor, good quality, \$350. Can deliver and set up. 905-439-4789

ComputerDeals.Net P-4 tower of power with CD-burner \$888. Pentium internet starter \$249. Laptops, big selection from \$399. New ultrafast 2-way satellite internet, available anywhere. We love doing upgrades & difficult repairs. (905)655-3661

COMPUTER LAPTOPS for sale. IBM Thinkpad laptop 366 MHz \$800. IBM PII 266 computer \$250. PII 500 \$350. More computers available. Call Al (416)569-7104.

CONTENTS SALE: Moving out of province, queen size bedroom suite \$350, floor console TV \$175; glass dinette set \$180; curio cabinet \$350, freezer, brand new \$175 non-smoker, like new, etc. 905-242-7300

DININGROOM 14 PCE cherrywood, 92" double pedestal, 8 Chippendale chairs. Buffet, hutch, server, dovetail construction. Still in boxes. Cost \$14,000. Sacrifice \$5000. (416)746-0995.

DIRECT T.V. Looped HU cards swapped \$60; HU unlooping \$60; Complete systems \$280; HU loaders \$100; AVR boards available. Installation kits \$20. Call (905) 259-0320

DSS SYSTEMS with 90 day program guarantee \$310. H and HU programming, private 3m script, \$50. 90 day guarantee. HU cards \$225. Card swap \$125.. Whitby (905) 721-9953

DTV RCA SATELLITE systems, complete with dual LNB, programmed hu card, H & HU card programming, installation available. Kirks Satellite Services, (905) 728-9670.

DIRECT TV EMULATION. Safeguard your Hcard now. B.S. too, emulate from \$175. Single IRD to multi IRD's with 1 card. Hidden Emuchip, leave #, immediate response. (416) 683-4987.

DIRECT TV: HU Card Programming. \$10 Pay Per View Cleaning. \$25 quick Fix (2 Month Guarantee) \$50 6 month unlimited programs (same card only). \$100 1 year unlimited programs (same card only) Bring 5 cards and 1 is free... Any Package!!!! Call 905-924-4223 Anytime.

DIRECT-TV PROGRAMMING H & HU Cards \$20 with 1 month guarantee. Systems, cards, emulations, loaders on sale. Call (905)430-9214

DISTRESSED SALE - Must sell! 3 steel building. Never erected. One is 50 x 100. Sacrifice prices. 1-800-221-5949.

DRESSERS \$45, 6 chairs \$25, beds \$25 each, stove \$50, bedroom suites \$195, antique oak buffet \$195, diningroom suite \$325, kitchen table & 4 chairs \$28, coffee and end table \$30, sofa \$150, pictures \$5 each, lamp \$8, many more items & antiques. 905-697-3532.

DSS SALE systems \$299 private H and HU card programming \$50 90 day warranty, unlooping \$70. HU \$200. HU loaders \$150. 905-668-4964. Whitby, 905-683-8565 Ajax, 905-985-7798 Port Perry.

ENTERTAINMENT CENTRE - holds TV up to 38", solid oak/glass doors, 62" wide x 20" deep x 52" high, like new, asking \$600. Call 905-665-6281

FILING CABINETS, used vertical and lateral, up to 70% OFF new list prices. Call 905-668-0800.

GOLF CLUBS Ping Iron set. O-size, including putter/wedge/bag plus Goliath, Stiletto II, Big Bertha, woods & driving irons. \$999.99. Please call 905-655-7283

HARDWOOD FLOORS FOR BETTER HEALTH. Prefinished and unfinished from \$2.49 sq.ft. Showroom: Kendalwood Plaza 1801 Dundas St. E., Whitby 905-433-9218. Oshawa Hardwood Floors Ltd.

325 Auctions

ATTENTION AUCTIONEERS!!
 Our "Auction Package" consists of your ad running weekly in these publications:
 • Oshawa Whitby This Week
 • Ajax Pickering News Advertiser
 • Port Perry This Week
 • Northumberland News
 • Uxbridge Tribune/Times Journal
 • Canadian Statesman/Clarington
One call does it all!!
Phone 576-9335
Fax 579-4218

310 Articles for Sale

OAK/PINE FURNITURE... We have expanded our showroom and are filling it with exciting New Designs in Solid Wood Bedrooms, Dining Rooms and Entertainment Units. We have a large selection available, and if you don't see what you are looking for, we will build to your specifications... Let Traditional Woodworking be your own personal FURNITURE MAKER. We have been building quality solid wood furniture in the Durham Region for 27 years. We pride ourselves on being able to take your ideas/plans and turn them into reality. Drop in and see our State of the Art Woodworking facility and let us show you how quality fine furniture is made... Remember... There is NO Substitute for Quality... Traditional Woodworking... 115 North Port Road (South of Reach Road), Port Perry. 905-985-8774. www.traditionalwoodworking.on.ca

LIVING ROOM COUCH - honey brown \$110. 905-373-6082.

LUIGI'S "Simmons" Mattress Salebration celebrate huge savings on all Simmons mattresses, including the no-flip series (\$799 Queen Set), and the do-not disturb pocket coil mats (\$899 queen set). Coil spring mattresses from \$89.. Futons from \$165.. Palliser leather and upholstery recliners and stationary sofas and loveseats, priced below wholesale. Now displaying pallisers' new spill resistant furniture. We're clearing our warehouse and passing on huge savings to our customers. Prices slashed on all futons, mattresses, sofas, love-seats, wing chairs, etc. no charge delivery and mattress removal for customer in this area. For the best quality at the lowest price, check us out first, our prices can't be beat. Luigi's Furniture, 488 King St. W., Oshawa (905) 436-0860.

MASSAGE TABLE, workshop portable with cradle & stool, 25 lbs. 2" foam \$200. (905)809-9226

MEAT GRINDER, meat saw and meat slicer, meat tenderizer, sausage stuffer, beam scale for sale. All items in excellent condition. Call 905-623-1436

MEN'S BLACK LEATHER COAT, 3/4 length, top quality, size 2X, \$250. 905-373-6082.

MOTORIZED WHEEL CHAIR, almost new. \$2,000 o.b.o. Call (905)686-9921

ANTIQU FRENCH door, with beveled glass windows, and with antique brass handle. 23" x 80". Excellent condition. \$150. 905-697-9462

NEW SNOWBLOWER, 10.5 hp Mastercraft, drift cutter, light, manual power steering, electric start \$900. WELDER EXERCISER, good condition \$200. 905-725-0694

PIANO TECHNICIAN available for tuning, repairs, & pre-purchase consultation on all makes & models of acoustic pianos. Reconditioned Heintzman, Yamaha, Mason & Risch, & other grand or upright pianos for sale. Gift Certificates available. Call Barb at 905-427-7631 or check out the web at: www.barbhall.com Visa, MC, Amex.

PIANO, mid-size, \$950; antique Hoosier \$1100; unique large sofa (blue)-ends recline, centre converts to table w/ storage drawer, separates for moving excellent condition, \$750 (paid \$1700). 905-831-6756

PLAYSTATION MOD CHIPS PS1 basic chip \$35; Stealth chip \$60; PS2 Version 1 & 2 \$75; Version 3 \$95; Version 4 \$125; All work guaranteed. Install while you wait. Beatrice/Wilson area (905)721-2365

RENT TO OWN new and reconditioned appliances, and new T.V.'s. Full warranty. Paddy's Market, 905-263-8369 or 1-800-798-5502.

SOLID OAK ENTERTAINMENT UNIT \$1500; solid oak dining suite \$1500; Oriental 4 panel screen \$1200; Oriental end table \$400; Oriental wall hanging \$100; Coffee table w/ brass tray \$400; appliances: fridge, stove, portable dishwasher \$900(3 items) other small items lamps +side chairs. 905-655-8563

SOLID WOOD bunkbeds with mattresses, like new with 2 white wardrobes \$600. obj: 11 pc. solid wood diningroom set \$600 obj. Little Tykes Country Kitchen with accessories \$50. obj. Call 905-728-9957.

YAMAHA 350H ELECTRIC GUITAR with 15 watt, Squier amp, hard guitar case, stand and patch cord. Asking \$375 OBO. 905-377-9983.

FREE FIREWOOD - Broken woodskids and pallets. Delivery available Oshawa Whitby/Ajax Pickering area. 905-434-0392. (snp)

LAKEBRIDGE FARM FIREWOOD, the best quality wood, seasoned cut/ split/ delivered. Discount for pickup. Volume discount. Serving Pickering, Ajax, Whitby, Oshawa, Courtice. Call anytime 905-922-3417

1991 Acura Integra LS Black, 2 door, 5 speed, loaded, 224 000km, \$4900 obj. Please call Justin 905-619-2749

1991 FIREBIRD, \$6500, 137K, certified, excellent cond., 905-623-4266.

1992 BUICK LESABRE Excellent condition, low miles, pdl, pw, p. seats. \$5900. 905-576-1320.

400 Cars For Sale

1995 GREEN WINDSTAR, pd, pw, pl, rear heat + air, runs excellent, no rust, easily certified. 144K, \$5500 firm. Call 905-728-3457

1997 GRAND PRIX SE, 3.8 V6, excellent condition, lady driven. P. windows, p. locks, air, am/fm cassette, cruise, 75,000 km. Asking \$13,500. Call 905-668-5254

1997 HYUNDAI ELANTRA station wagon, dark green, auto, cruise, AM/FM cass., roof racks, 155,000 highway kms., carefully maintained, excellent condition, certified and emission tested, \$8,500 OBO. Call 905-377-1542.

1997 PONTIAC Grand Prix SE, 140,000 k., loaded, power steering, power windows, 10 disk cd., 4,000 kil., left on GM warranty, \$14,500 or best offer. (905) 576-7002.

1999 HONDA CIVIC, auto, air, e-tested, power doors, am/fm, 80,000km. \$13,000 o.b.o. Call (905)404-1417.

1999 SUNBIRD, 1998 Corsica, 1999 Caravan, certified and e-tested. Best offer. (905) 404-5783

NEED A CAR?? We Finance Your Future... Not Your Past!
 • Bankrupt?
 • Slow pay?
 • Divorced?
 • New to country?
Call the Finance Doctor "Kevin"
905-831-2693 ext. 309
 Michael Boyer
 Pontiac Buick
 GMC Ltd.

FREE BABY GUINEA PIGS, Call 905-428-0132.

MINIATURE SCHNAUZER puppies, 2 females born January 12th, non-shedding, first shots, dew claws removed, vet checked, \$550 each. Call (905)655-9745

Papillon Pups 6 weeks m-\$450 f-\$500 14 month f ready for breeding Call evenings 905-986-9955.

REGISTERED GERMAN Shepherd puppies, great temperament, family raised, reasonable. Call (905)986-0425

ROSCOE'S RESCUE has for adoption 4 female, Samoyed X Lab puppies, 6 weeks old, 2 white and 2 black with white. A 3 year old male American Pit Bull, white with patches, named Lunker, a 8 month old, brindle, male American Pit Bull named Blazer, very sweet. A 3 month old, tan and white, female spayed American Pit Bull named Peppy. Adoption fee applied. SERIOUS INQUIRIES ONLY. Please call 905-355-5781 www.geocities.com/roscoesrescuecanada

WE FINANCE EVERYONE First time buyers, bankrupt, bad credit, no credit. You work? You drive! Lots of choice. Down or Trade may be required. SPECIAL FINANCE DEPARTMENT SHERIDAN CHEV 905-706-8498

NEED A CAR? Rebuild Your Credit with Newstart Leasing! AS LOW AS \$199 DOWN 1-866-570-0045

1986 OLDSMOBILE Cutlass supreme, 305 engine, 195,000Kms, \$700. Call Greg (905)723-8284

1986 OLDSMOBILE FIRENZA, auto, 170,000 km, 2L, air, pb, emission tested & safety check, \$1000 obj. Call 432-1299 8 a.m. - 3 p.m

1987 MUSTANG, 2 dr. LX hatchback, 150,000 km, auto, 4 cyl, white with blue interior, body ok, runs great. Certified, \$1400. obj. 905-686-0053 leave a message.

1987 PONTIAC 6000 wagon, 6-cylinder, 2.8L fuel injected motor, automatic/overdrive, sunroof, luggage rack, AM/FM cassette, very good condition, no rust, great running car. Certified/Emissions. \$2500 905-431-1209

1988 CHRYSLER LABARON GTS, auto, 4 cyl. turbo engine, 4 dr, lady driven, certifiable, E-tested last Aug. Asking \$1500 obj. Call 905-576-2251.

1989 GREY 5-SPD. Cavalier 224, mint cond., runs great, \$3000 o.b.o. Call (905)431-5463

1991 GMC JIMMY, 4WD, many new parts, new tires, 2-tone grey on grey, 350,000 km. \$3000. obj. Phone 416-684-4816 days; 905-436-2440 eve.

1990 GMC SIERRA, white 4x4, 305, 5-sp, certified & emission tested, very good condition, \$5500. Call 905-576-1483.

1992 10X extacab 1 owner truck, needs engine \$1500. Box trailer 12'X6'X4' high, with removable top. \$950. 905-433-0775.

1996 EXT. CAB SILVERADO, fully loaded, 305 Vortec, new engine in Nov., receipts provided. \$13,500. Call Tony at 905-697-1559.

2000 FORD TAURUS SE, silver w/grey interior, 4-door, loaded, 3yr lease ends Feb. 2003. Only 38,000km with 75,000km lease. Call after 7pm (705) 786-3124.

AFFORDABLE USED CARS - LOW PAYMENTS! 95 Mazda Protege, air, pwr. 95 Dodge Spirit V6, 98 Tiburon, 52K, 5-sp. 98 Elantra 58K, 98 Accent 2dr. Financing Available. Pickering Hyundai (905)427-0111.

CAR FOR SALE 1999 BLACK Pontiac Grand Am, excellent condition, 50,000km, selling cheap \$15,500. Nazir 905-430-9445

273 Daycare Available

INFANTS - 12 YEARS OLD
 In caring, safe, fun home environment.
 Licensed by M.C.S.S.
 Reasonable rates
 Receipts, flexible hours. Call
DURHAM PROFESSIONAL HOME DAYCARE 905-509-1200

410 Trucks For Sale

1997 GMC SIERRA LSE 4 x 4, loaded, 350 motor, matching cap, 82,000 kil., \$18,500. Telephone (905) 432-9117

TRUCK CAP FOR SALE - fits long box S10 - S15 \$100 OBO. Call Justin at 905-885-2028.

1998 CARAVAN, 7 passenger, excellent condition, air, tinted glass, roof rack, 158,000 kms., extended warranty, certified & E-tested, no GST \$8250. Call 905-430-3317

1999 DODGE GRAND CARAVAN SE, loaded, 54,000km, am/fm cassette. \$14,900 o.b.o. Call (905)434-2775 or 416-331-2858

TWO 1988 DODGE VANS, one ambulance, one school bus, good running condition, extended, one-ton, V8 ; Also 1988 Ford Custom 150 Econoline, pw, pl, cruise, am/fm cassette, carpeted inside. Call 905-434-0392

255 Announcements

NO TIME TO TALK Why not Fax us your ad! You can use your fax machine to send us your advertisement. Please allow time for us to confirm your ad copy and price prior to deadline. One of our customer service representatives will call you. Please remember to leave your company name, address, phone number and contact name.

Fax News Advertiser 905-579-4218

MONEY PROBLEMS? Judgements, garnishment, mortgage foreclosures & rassing creditor calls. Debt Consolidations, & tention for your assets. now: 905-576-3505

700 Home Improvement

BASEMENT WATERPROOFING Offices Renovations Etc. CALL DOUG (905)426-1611

BUDGET HOME IMPROVEMENT Bathroom renovation, new kitchen counter and kitchens, finished basements, rec. rooms and decks, 20 yrs. Exp.

Barrier Free Renovation call Mario (905) 619-4663 Cell (416) 275-0038

CARPENTRY kitchens & Bathrooms doors - windows - garage - drywall - basements - ceramic tile, crown moulding, Wood deck interior & exterior. Aluminum & Vinyl siding Flooring, R. Gravel Carpentry (905) 579-7040

NEED HELP with an IMMIGRATION or CRIMINAL MATTER? 905-436-6278 (Oshawa) Reasonable Rates

261 Legal Notices

268 Personals

ENERGY WORKER available (Reiki Master, Crystal Healer, Ear-caning Therapist) Maureen McBride's Healing/Energy Clearing media documented, including Toronto Sun. Four years success treating leukemia, cancers; chronic pain management; dissolving child-adulthood traumas/issuses. 905-683-1360 days, eves, weekends

HEAVENLY PSYCHIC Answers. Find the oracle within. \$2.99/min. *18+*24 hrs. 1-900-451-3783.

410 Trucks For Sale

1991 GMC SIERRA, white 4x4, 305, 5-sp, certified & emission tested, very good condition, \$5500. Call 905-576-1483.

1992 10X extacab 1 owner truck, needs engine \$1500. Box trailer 12'X6'X4' high, with removable top. \$950. 905-433-0775.

1996 EXT. CAB SILVERADO, fully loaded, 305 Vortec, new engine in Nov., receipts provided. \$13,500. Call Tony at 905-697-1559.

SPECIAL Kitchen & Baths Basement, ceramic tile crown moulding Renovations No payment for 12 months (416)333-5971

Lightning novices overpower U.S. foes to win crown

DURHAM — The Durham West Lightning Tormina Homes novice 'A' rep hockey team blanked the Birmingham Rangers 3-0 to capture the championship at the Michigan Golden Blades Tournament recently.

The Lightning novices were overpowering in the event, outscoring their opponents 31-0 en route to the championship.

Brittney Sullivan opened the scoring early in the second period on a three-way

passing play from Colleen Broaderip and Stefanie Thomson. Kelsie Moffatt and Megan Hagg added third-period markers, assisted by Erin Cameron.

Danielle Cyr was outstanding to earn her second shutout of the tournament.

The Lightning started the tournament by blanking Birmingham 6-0.

Robyn Crumme scored twice, while Broaderip, Katie Wailes, Jennifer Grant and Michelle Sabourin added singles.

The host Michigan team was no match for the Durham West girls as they outscored the Capitals 13-0.

Wailes paced the Lightning with five goals; Thomson and Shannon Baker chipped in with two goals apiece, while Crumme, Shannon Stoneburgh, Moffatt and Cameron had one apiece.

Drawing assists for the Lightning were Stoneburgh, Broaderip, Cameron, Wailes, Grant, Moffatt, Baker and Julianne Linde-

blom.

Hagg earned the shutout in net.

In game 3, the Lightning stormed to Westland FlyHers en route to a 9-0 rout. Sabourin notched a hat trick; Broaderip, Stoneburgh, Grant, Thomson, Hagg and Baker added single markers.

Richard Sabourin coaches the team, assisted by Ryan Sabourin. The trainer is Erin Broaderip and the manager is Chy-

Advertising Feature

Health & Wellness

Your Guide to Healthy Living

COMMUNITY NEWS

Durham Access To Care's Entire Board and CEO Reappointed by Lieutenant Governor-in-Council under Bill 130

Effective February 16th, Durham Access To Care (DATC) has been converted to a statutory corporation along with the other Community Care Access Centres (CCACs) in Ontario. All Board Members and Executive Directors are now appointed by Order-In-Council.

"The appointment of the pre-existing board and CEO is an affirmation of the hard work and skillful leadership that has been demonstrated at DATC," said William Botshka, past and newly appointed Board Chair. "Our focus remains the same; clients are our first concern," Botshka said, "We welcome any changes that will enhance client services."

Janet Harris, Chief Executive Officer who has been reappointed as the Executive Director, said "The Board's commitment to the work of our organization is clearly demonstrated by their willingness to continue to provide governance at DATC".

Durham Access To Care Board of Directors

William Botshka, Pickering
Mary Bazeley, Whitby
Janette Taggart, Oshawa
Simone Lusty, Sunderland
Maureen Wishart, Whitby
Elizabeth McCreight, Oshawa

Barbara Hiemstra, Oshawa
Howard Hall, Port Perry
Lynn West, Pickering
Connie Vesna, Pickering
Marek Ulanicki, Whitby

DATC is one of 43 CCACs in Ontario responsible for the delivery of home and school-based services and admissions to long-term care facilities. For more information please view our website at www.datc.org

For further information please call:

Paula Landry (1-800-263-3877)
Acting Community & Public Relations Coordinator
209 Dundas Street East
Whitby, Ontario L1N 7H8

Oshawa • Whitby • Clarington • Port Perry

This Week & NEWS ADVERTISER
THE COMMUNITY NEWSPAPER SINCE 1965

Presents
Health & Wellness
Your Guide to Healthy Living

Sunday April 7th, 2002
11 a.m. 'til 8:30 p.m.

at The Jubilee Pavilion
55 Lakeview Park, Oshawa

FREE ADMISSION FREE PARKING

- Demonstrations
- Lectures
- Product Demos

SPECIAL SECTION PUBLISHING FRIDAY, APRIL 5TH

EARLY ON-LINE COMPANY BIOS

RESERVE YOUR BOOTH SPACE TODAY!

For Further Information Please Call!
Phone 905-579-4400 or Fax 905-579-2742

164 Tax & Financial 164 Tax & Financial 700 Home Improvements 700 Home Improvements 705 Handyman 735 Gardening & Landscaping 735 Gardening & Landscaping 258 In Memoriam 258 In Memoriam

INCOME TAXES
Tired of Crunching Numbers on Your Own?
Serving Scarborough & the Durham Region for over 20 years. Extended hours available.
Gurney & Associates 416-284-0022

CANDO RENOVATIONS INC.
METRO LICENCE B2195
For all your Quality Renovations
Basements, Windows, Bathrooms
Additions electrical gas fireplaces etc.
Off. 905-686-5211 Fax 905-686-8072
ALSO MAKING HOMES & ACCESSIBLE
Since 1975

DICK'S HANDYMAN Service & Maintenance
• Carpentry • Drywall
• Licensed Electrical
• Plumbing • Ceramic Tile
15 Years Exp.
10% discount for seniors
416-528-3945

4th ANNUAL GARDEN & LANDSCAPE SHOW
Children's Arena Oshawa
April 12, 13, 14
Vendor Space Available
Call Sharon Dickson
905-579-4400 ext. 2285
to reserve your booth
Sponsored by:
Oshawa Whitby This Week

In Loving Memory of A Wonderful Wife, Mother & Grandmother
Donna Marie Hnatiuk (nee Archer)
September 9th, 1937 - February 24, 1997

Mom,
You have been gone from this earth for long years now, but never from our hearts.

We remember so fondly your wonderful ways and all of the happy, special times had with you when were here.

We are more at peace now with the healthy passage of time, but more so, because we know that one-day we will meet again.

♥ With our Love ♥
Husband Ted
Daughters ~ Lorraine, Karen, Donna,
Jennifer & families

Mortgages & Loans
Consolidate Christmas Bills
Refinancing, Purchases
Debt Consolidations
Free Consultations
No upfront fees
Call today
A.M.S. Accurate Mortgage Services Inc.
905-436-9292 or toll free
1-877-509-LOAN

RDC WINDOWS, DOORS & ROOFING
Since 1969
Quality Products - Workmanship Guarantees
Transferable Warranties
"WE'RE WORTH LOOKING INTO"
(905) 686-9494
• Porch Enclosures • Garage Doors
Any purchase over \$1,500, get a
"Free storm door installed"
or visit www.rdcworld.com

All Pro Painting and Wallpapering
Stucco ceilings, General repairs, Top quality work at reasonable prices
20% off for Seniors
Call for a FREE Estimate
404-9669

RABBIT WANTS WORK
Doing Magic For Children's Parties
And All Occasions. Have My Own Magician.
Call Ernie **668-4932**

753 Party Services
910 Massage
OSHAWA'S modern wellness
Aroma full body treatment
plus hot tub. 905-579-2715

ROOFING • SKYLIGHTS EAVESTROUGH
Fully Insured Free Estimates
MIDWAY HOME IMPROVEMENTS INC.
905-427-8613
1-866-688-5923

Handyman CONNECTION
RETIRED CRAFTSMEN & OTHER EXPERTS FOR LOW COST HOME REPAIRS & REMODELING
• Plumbing • Carpentry • Electrical
• Painting & Much More
Insured, Bonded, 1 Year warranty
905-686-7236

"GUARANTEED PAINTING & STUCCO CEILINGS"
Residential - Commercial
Interior - Exterior
Refinish - Repair - Repaint
Stucco Ceilings
"PAY AS YOU ARE SATISFIED"
Call Scott for Free Estimate @
(416) 414-5911
(32 years experience)
Senior's Discount

CLOWN / MAGICIAN
• Live animals • All occasions
• All ages
Call Jeff
(905) 839-7057

KIDS UNLIMITED
Children's entertainment for any occasion.
BLUE RIBBON AWARD WINNER.
Clowns, character look-alikes, loot bags, face painting, magic, music.
905-471-5331

KING HOME IMPROVEMENTS
Basement Apartments, Kitchens, Bathrooms, Wet Basements
Additions, Electrical, Plumbing
22 years experience
Mike (905)683-0190 or (416)885-4682

HOMEPRIDE IMPROVEMENTS
Quality Painting Decorating & Renovations
For Free Estimate
Call Don
(905) 626-2111
Fully Insured
allaini@sprint.ca

TMS PAINTING & DECOR
Interior & Exterior European Workmanship
Fast, clean, reliable service.
428-0081

ACTIVE MOVING SYSTEMS
Houses, Apartments, Offices, Appliances & Piano Specialists.
Packing & Storage, boxes available.
Licensed & insured. Free Estimates.
Professional service.
Call **(905)436-7795**.

900 Dating Services
FRIENDS AND LOVERS DATING SERVICE! Durham's Own! Find your mate, or just share a moment. Listen to all the voice ads free. Women free to meet men. (905)-683-1110.

MURPHY'S HOME IMPROVEMENT SERVICES
Hardwood flooring, trim work, decks, fences, ceramic tiles, custom woodworking, garden sheds, drywall, much more.
Quality workmanship. 17 years experience
Call James
(905) 839-4041

DOORS "R" US
GARAGE DOORS, OPENERS, (We install), FIX BROKEN SPRINGS, CABLES, ROLLERS. Sales Service & Repairs
905-837-0949
Fax us your ad at 683-0707

700 Home Improvements
Stone Properties
Garage Door Openers \$75
Finished Basements, Garden, Fences, Sheds, Painting, Decorating Tiling, Wooden Floors, Paving, Decks, Kitchens, Electrical Plumbing, Windows Doors, Renovations
Amir 905-619-9330

702 Garbage Removal Hauling
GARBAGE REMOVAL
For People With Limited Cash Flow
Garage is for cars Basement for relaxation
Call Joseph
(905) 428-7528 or cell **(905) 626-6247**

ROMEO PAINTING
Specializing in interior and exterior painting. For clean fast and reliable service
Call **(905) 686-9128**

Fax us your ad at
905-683-0707

THE HONEST MOVER
\$75 PER HOUR - 2 men
Big or small we do them all
RUBBISH REMOVAL
Licensed Company
INSURED
Local or Long Distance
(905) 665-0448
Pager 720-8438

905 Adult Entertainment
Exclusively Yours
♥Upscale♥
Escort Service
Serving Durham Region
Discretion Guaranteed
Open 9 a.m. Daily
(905) 725-2322
Now Hiring 18+

TO ADVERTISE YOUR BUSINESS OR SERVICE IN THIS SECTION PLEASE CALL AJAX 905-683-0707

Get the Jump on Spring with **CRAZY DEALS AT DAVIDSON CHRYSLER MANAGER'S SPECIALS**



2000 CHRYSLER LHS
Loaded, Loaded! p. windows, locks, roof, etc.
Low, low kms and priced to sell now!
Stk#5434A.
\$22,998**



**1999 DODGE RAM 1500
LARAMIE SLT**
Pw, pi, shortbox, 2 wheel drive.,
Just like new!
\$16,988**

2001 CHRYSLER CONCORDE
Loaded, pw, pl, pm, tilt, cruise, power seat, luxury. Stk#5649A
\$18,988**

2001 CHRYSLER SEBRING
PW, PL, PM, tilt, cruise, 15" wheels
\$17,888**

2001 CHRYSLER INTREPID
Loaded, pw, pl, pm, tilt, cruise.
\$18,488**

1999 DODGE NEON
4 dr., auto, air. Only 47K, low km for this
year. Stk#68958A.
\$9,985**

1998 DODGE AVENGER
Air, tilt, cruise, pw, pl, pm, Low on 57 kms.
Stk#75062A Loaded!
\$15,989**

1998 DODGE NEON
4 dr., auto, air, low kms. 2 to choose. Stk#5611A.
From
\$8,995**

1998 PLYMOUTH NEON EXPRESSO
2 door., 5 speed, power roof, loaded, only 54kms. As is spe-
cial. You safety, You save! Stk#5693A
\$9,995**

2000 DODGE CARAVAN
V6, 7 pass. Our best seller is on sale!
Low kms. Stk#5584A.
\$16,488**

1999 PONTIAC TRANSPORT
V6, 7 pass., auto, air, only 46K. Must sell!!! Make
you best deal now!!!
\$14,896**

1999 GRAND CARAVAN SPORT
Loaded, pw, pl, tilt, air, cruise, quads, rear air, loaded!
7 pass. A must see! Stk#78518A
\$16,892**

1998 PLYMOUTH VOYAGER
Ideal, 7 passenger, auto., ps, pb. Stk# 68910A.
\$11,988**

1999 DODGE CARAVAN
V6, loaded, pw, pl, pm, dual doors, low kms
Stk#5656A
\$14,888**

1999 GRAND VOYAGER EXPRESSO
CD, quad seats, low kms, Stk#5653A
\$18,488**

1998 GRAND CARAVAN ES
Fully equipped, luxury model. Quads, all the toys! You will not be
disappointed! Low kms. Stk#68605A
\$17,999**

2001 GRAND CHEROKEE LAREDO
Loaded, pw, pl, pm, 4x4 select trac. Tilt, cruise, cast wheels, bal-
ance of factory warranty. Low kms. Former rental. Stk#5492A
\$29,688**

1999 GRAND CHEROKEE LTD.
Leather, pw, pl, pm, tilt, cruise, air, p. roof, all the toys. Call today
to save. Low kms Stk#5619A
\$29,988**

1997 DODGE DAKOTA REG. CAB
Auto, 6 cyl., power steering, power brakes, matching
taneau cover.
\$11,988**

1998 JEEP GRAND CHEROKEE LAREDO
Pw, pl, pm, tilt, cruise, only 47K Stk#5658A
\$20,988**

1999 DODGE RAM 1500 SLT SPORT
2wd, quad cab loaded, bedliner, low kms. Don't wait!
\$21,988**

1999 DODGE DAKOTA CLUB CAB
V6, auto, only 47K
\$16,988**

**All sale prices are plus GST, PST, gas, lic. fee & admin. OAC.

**SCARBOROUGH HOTLINE
416.287.7777
AJAX/PICKERING HOTLINE
1.800.465.8142**



4695 KINGSTON ROAD

